

SONY®

4-732-885-11(1)



* 4 7 3 2 8 8 5 1 1 * (1)

Television

Operating Instructions

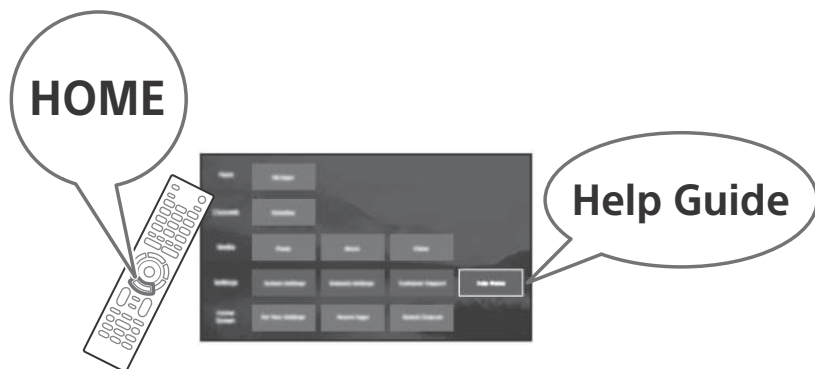

BRAVIA

KD-65X7000F / 55X7077F / 55X7000F / 49X7077F / 49X7000F / 43X7000F

Table of Contents

Safety Information	3
Precautions	5
Parts and Controls	7
TV	7
Remote Control	8
Connecting TV to the Internet	10
Setting up the Internet Connection	10
Watching TV	10
Viewing Pictures from Connected Equipment	11
Connection Diagram	11
Additional Information	12
Installing the TV to the Wall	12
Troubleshooting	17
Specifications	18

Introduction

Thank you for choosing this Sony product. Before operating the TV, please read this manual thoroughly and retain it for future reference.

Note

- Before operating the TV, please read the "Safety Information" (page 3).
- Instructions about "Installing the TV to the Wall" are included within this TV's instructions manual.
- Images and illustrations used in the Setup Guide and this manual are for reference only and may differ from the actual product.

Attaching the Table-Top Stand to the TV

Refer to the Setup Guide on top of the cushion.

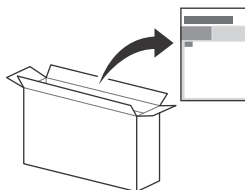

Help Guide (Manual)

For more detailed information, press **HOME** on the remote control, then select [Help Guide] under [Settings] menu. You can also check the Help Guide from your PC or smartphone (information provided on the back cover).

Location of the identification label

Labels for the TV Model No. and Power Supply rating are located on the rear of the TV.

For models with supplied AC adapter:

Labels for the AC adapter Model No. and Serial No. are located on the bottom of the AC adapter.

Notice for customers in Thailand

This telecommunication equipment and device conforms with NBTC standard or NBTC requirements.

This radio communication equipment has the electromagnetic field strength in compliance with the Safety Standard for the Use of Radio communication Equipment on Human Health announced by the National Telecommunications Commission.

Notes for Australia and New Zealand model

This product is ENERGY RATING qualified in the [Home] mode. ENERGY RATING is a programme designed to promote energy efficient products and practices.

- When the TV is initially set up, it is designed to meet ENERGY RATING requirements while maintaining optimum picture quality.
- Changes to certain features, settings and functionalities of this TV (e.g. TV Guide, Picture/Sound, Eco setting) can slightly change the power consumption.

Depending upon such changed settings (e.g. [Shop] mode), the power consumption may vary which possibly could exceed the stated energy rating.

To reset the TV to ENERGY RATING qualified settings, select [Home] mode from the initial set-up procedure in [Factory Settings] under the [Customer Support] menu.

Safety Information

WARNING

Caution

Risk of explosion if the battery is replaced by an incorrect type. Batteries must not be exposed to excessive heat such as sunshine, fire or the like or extremely low air pressure that can result in an explosion or leakage of flammable liquid or gas.

Stability Hazard

The television set may fall, causing serious personal injury or death.

Never place a television set in an unstable location. A television set may fall, causing serious personal injury or death. Many injuries, particularly to children, can be avoided by taking simple precautions such as:

- Using cabinets or stands recommended by the manufacturer of the television set.
- Only using furniture that can safely support the television set.
- Ensuring the television set is not overhanging the edge of the supporting furniture.
- Not placing the television set on tall furniture (for example, cupboards or bookcases) without anchoring both the furniture and the television set to a suitable support.
- Not placing the television set on cloth or other materials that may be located between the television set and supporting furniture.
- Educating children about the dangers of climbing on furniture to reach the television set or its controls.

If your existing television set is being retained and relocated, the same considerations as above should be applied.

Installation/Set-up

Install and use the TV set in accordance with the instructions below in order to avoid any risk of fire, electric shock or damage and/or injuries.

Apparatus connected to the protective earthing of the building installation through the mains connection or through other apparatus with a connection to protective earthing – and to a television distribution system using coaxial cable, may in some circumstances create a fire hazard. Connection to a television distribution system therefore has to be provided through a device providing electrical isolation below a certain frequency range (galvanic isolator, see EN 60728-11).

Installation

- The TV set should be installed near an easily accessible AC power outlet (mains socket).
- Place the TV set on a stable, level surface to prevent it from falling over and causing personal injury or property damage.
- Install the TV so that the TV's Table-Top Stand does not protrude out from the TV stand, it may cause TV set to topple over, fall down, and cause personal injury or damage to the TV.

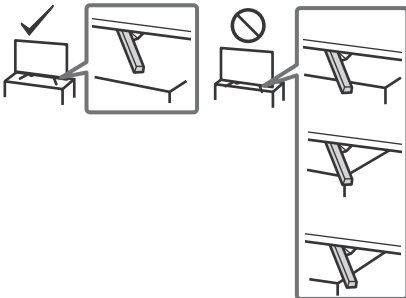

- Only qualified service personnel should carry out wall-mount installations.
- For safety reasons, it is strongly recommended that you use Sony accessories, including:
Wall-Mount Bracket: SU-WL450
- Be sure to use the screws supplied with the Wall-Mount Bracket when attaching the Wall-Mount Bracket to the TV set. The supplied screws are designed as indicated by illustration when measured from the attaching surface of the Wall-Mount Bracket. The diameter and length of the screws differ depending on the Wall-Mount Bracket model.
Use of screws other than those supplied may result in internal damage to the TV set or cause it to fall, etc.

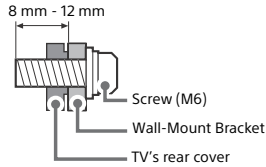

Transporting

- Before transporting the TV set, disconnect all cables.
- Two or three people are needed to transport a large TV set.
- When transporting the TV set by hand, hold it as shown below. Do not put stress on the LCD panel and the frame around the screen.
- When lifting or moving the TV set, hold it firmly from the bottom.

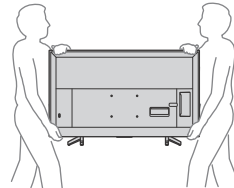

- When transporting the TV set, do not subject it to jolts or excessive vibration.
- When transporting the TV set for repairs or when moving, pack it using the original carton and packing material.

Topple prevention

(Except models with supplied support belt kit)

KD-65/55X7000F, KD-55X7077F

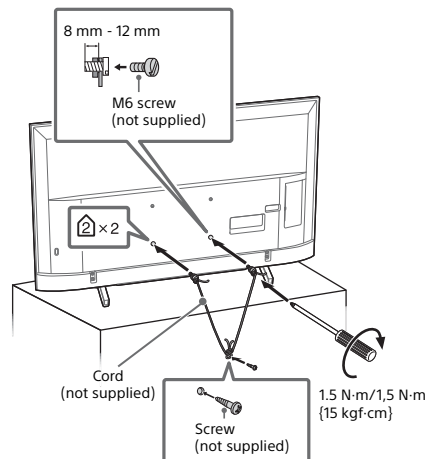

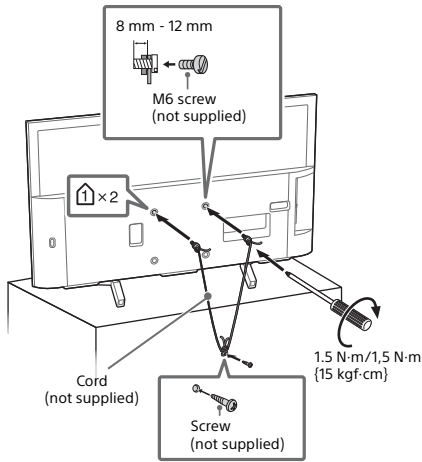

Ventilation

- Never cover the ventilation holes or insert anything in the cabinet.
- Leave space around the TV set as shown below.
- It is strongly recommended that you use a Sony Wall-Mount Bracket in order to provide adequate air circulation.

Installed on the wall

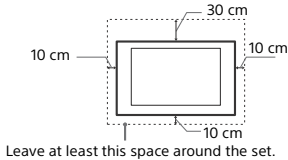

Leave at least this space around the set.

Installed with stand

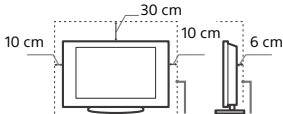

Leave at least this space around the set.

- To ensure proper ventilation and prevent the collection of dirt or dust:
 - Do not lay the TV set flat, install upside down, backwards, or sideways.
 - Do not place the TV set on a shelf, rug, bed or in a closet.
 - Do not cover the TV set with a cloth, such as curtains, or items such as newspapers, etc.
 - Do not install the TV set as shown below.

Air circulation is blocked.

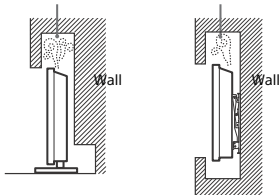

AC power cord (mains lead)

Handle the AC power cord (mains lead) and outlet (mains socket) as follows in order to avoid any risk of fire, electric shock or damage and/or injuries:

- The shape of AC power plug (mains plug), which is supplied with the TV set, varies depending on the regions. Be sure to connect the appropriate supplied AC power cord (mains lead) with the plug that fits into the AC power outlet (mains socket).
- Use only Sony supplied AC power cords (mains lead), not those of other brands.
- Insert the plug fully into the AC power outlet (mains socket).
- Operate the TV set on a 100 V - 240 V AC supply only.
- When wiring cables, be sure to unplug the AC power cord (mains lead) for your safety and take care not to catch your feet on the cables.
- Disconnect the AC power cord (mains lead) from the AC power outlet (mains socket) before working on or moving the TV set.
- Keep the AC power cord (mains lead) away from heat sources.
- Unplug the AC power plug (mains plug) and clean it regularly. If the plug is covered with dust and it picks up moisture, its insulation may deteriorate, which could result in a fire.

Note

- Do not use the supplied AC power cord (mains lead) on any other equipment.
- Do not pinch, bend, or twist the AC power cord (mains lead) excessively. The core conductors may be exposed or broken.
- Do not modify the AC power cord (mains lead).
- Do not put anything heavy on the AC power cord (mains lead).
- Do not pull on the AC power cord (mains lead) itself when disconnecting the AC power cord (mains lead).
- Do not connect too many appliances to the same AC power outlet (mains socket).
- Do not use a poor fitting AC power outlet (mains socket).

NOTE ON AC ADAPTER (models with supplied AC adapter only)

Warning

To reduce the risk of fire or electric shock, do not expose this apparatus to rain or moisture.

To prevent fire or shock hazard, do not place objects filled with liquids, such as vases, on the apparatus.

Do not install this equipment in a confined space, such as a bookshelf or similar unit.

- Please ensure that the AC power outlet (mains socket) is installed near the equipment and shall be easily accessible.
- Be sure to use the supplied AC adapter and AC power cord (mains lead). Otherwise it may cause a malfunction.
- Connect the AC adapter to an easily accessible AC power outlet (mains socket).
- Do not coil the AC power cord (mains lead) around the AC adapter. The core wire may be cut and/or it may cause a malfunction of the TV.

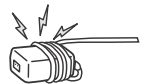

- Do not touch the AC adapter with wet hands.
- If you notice an abnormality in the AC adapter, disconnect it from the AC power outlet (mains socket) immediately.
- The set is not disconnected from the AC source as long as it is connected to the AC power outlet (mains socket), even if the set itself has been turned off.
- As the AC adapter will become warm when it is used for a long time, you may feel hot when touching it by hand.

Prohibited Usage

Do not install/use the TV set in locations, environments or situations such as those listed below, or the TV set may malfunction and cause a fire, electric shock, damage and/or injuries.

Locations:

- Outdoors (in direct sunlight), at the seashore, on a ship or other vessel, inside a vehicle, in medical institutions, unstable locations, near water, rain, moisture or smoke.

Environments:

- Places that are hot, humid, or excessively dusty; where insects may enter; where it might be exposed to mechanical vibration, near flammable objects (candles, etc.). The TV set shall not be exposed to dripping or splashing and no objects filled with liquids, such as vases, shall be placed on the TV.

Situations:

- Use when your hands are wet, with the cabinet removed, or with attachments not recommended by the manufacturer. Disconnect the TV set from AC power outlet (mains socket) and antenna (aerial) during lightning storms.
- Install the TV so that it sticks out into an open space. Injury or damage from a person or object bumping into the TV may result.



- Place the TV in a humid or dusty space, or in a room with oily smoke or steam (near cooking tables or humidifiers). Fire, electric shock, or warping may result.



- Install the TV in places subject to extreme temperature such as in direct sunlight, near a radiator or a heating vent. The TV may overheat in such condition which can cause deformation of the enclosure and/or TV malfunction.



- If the TV is placed in the changing room of a public bath or hot spring, the TV may be damaged by airborne sulfur, etc.



- For best picture quality, do not expose the screen to direct illumination or sunlight.
- Avoid moving the TV from a cold area to a warm area. Sudden room temperature changes may cause moisture condensation. This may cause the TV to show poor picture and/or poor colour. Should this occur, allow moisture to evaporate completely before powering the TV on.

Broken pieces:

- Do not throw anything at the TV set. The screen glass may break by the impact and cause serious injury.
- If the surface of the TV set cracks, do not touch it until you have unplugged the AC power cord (mains lead). Otherwise this may cause an electric shock.

When not in use

- If you will not be using the TV set for several days, the TV set should be disconnected from the AC power (mains) for environmental and safety reasons.
- As the TV set is not disconnected from the AC power (mains) when the TV set is just turned off, pull the plug from the AC power outlet (mains socket) to disconnect the TV set completely.
- Some TV sets may have features that require the TV set to be left in standby to work correctly.

For children

- Do not allow children to climb on the TV set.
- Keep small accessories out of the reach of children, so that they are not mistakenly swallowed.

If the following problems occur...

Turn off the TV set and unplug the AC power cord (mains lead) immediately if any of the following problems occur.

Ask your dealer or Sony service centre to have it checked by qualified service personnel.

When:

- AC power cord (mains lead) is damaged.
- Poor fitting of AC power outlet (mains socket).
- TV set is damaged by being dropped, hit or having something thrown at it.
- Any liquid or solid object falls through openings in the cabinet.

About LCD TV Temperature

When the LCD TV is used for an extended period, the panel surrounds become warm. You may feel hot when touching there by the hand.

Precautions

Viewing the TV

- View the TV in moderate light, as viewing the TV in poor light or during long period of time, strains your eyes.
- When using headphones, adjust the volume so as to avoid excessive levels, as hearing damage may result.

LCD Screen

- Although the LCD screen is made with high-precision technology and 99.99 % or more of the pixels are effective, black dots may appear or bright points of light (red, blue, or green) may appear constantly on the LCD screen. This is a structural property of the LCD screen and is not a malfunction.
- Do not push or scratch the front filter, or place objects on top of this TV set. The image may be uneven or the LCD screen may be damaged.
- If this TV set is used in a cold place, a smear may occur in the picture or the picture may become dark. This does not indicate a failure. These phenomena disappear as the temperature rises.
- Ghosting may occur when still pictures are displayed continuously. It may disappear after a few moments.
- The screen and cabinet get warm when this TV set is in use. This is not a malfunction.
- The LCD screen contains a small amount of liquid crystal. Follow your local ordinances and regulations for disposal.

Handling and cleaning the screen surface/cabinet of the TV set

Be sure to unplug the AC power cord (mains lead) connected to the TV set from AC power outlet (mains socket) before cleaning. To avoid material degradation or screen coating degradation, observe the following precautions.

- To remove dust from the screen surface/cabinet, wipe gently with a soft cloth. If dust is persistent, wipe with a soft cloth slightly moistened with a diluted mild detergent solution.
- Never spray water or detergent directly on the TV set. It may drip to the bottom of the screen or exterior parts and enter the TV set, and may cause damage to the TV set.



- Never use any type of abrasive pad, alkaline/clear cleaner, scouring powder, or volatile solvent, such as alcohol, benzene, thinner or insecticide. Using such materials or maintaining prolonged contact with rubber or vinyl materials may result in damage to the screen surface and cabinet material.
- Periodic vacuuming of the ventilation openings is recommended to ensure proper ventilation.
- When adjusting the angle of the TV set, move it slowly so as to prevent the TV set from moving or slipping off from its table stand.

Optional Equipment

Keep optional components or any equipment emitting electromagnetic radiation away from the TV set. Otherwise picture distortion and/or noisy sound may occur.

Wireless Function of the unit

- Do not operate this unit near medical equipment (pacemaker, etc.), as this may result in the malfunction of the medical equipment.
- Although this unit transmits/receives scrambled signals, be careful of unauthorised interception. We cannot be responsible for any trouble as a result.

Caution about handling the remote control

- Observe the correct polarity when inserting batteries.
- Do not use different types of batteries together or mix old and new batteries.
- Dispose of batteries in an environmentally friendly way. Certain regions may regulate the disposal of batteries. Please consult your local authority.
- Handle the remote control with care. Do not drop or step on it, or spill liquid of any kind onto it.
- Do not place the remote control in a location near a heat source, a place subject to direct sunlight, or a damp room.

Disposal of the TV set



Disposal of old electrical & electronic equipment (applicable in the European Union and other countries with separate collection systems)



Notice for customer in UAE

TRA

REGISTERED No: ER48327/16

DEALER No: DA0105422/13

Parts and Controls

TV

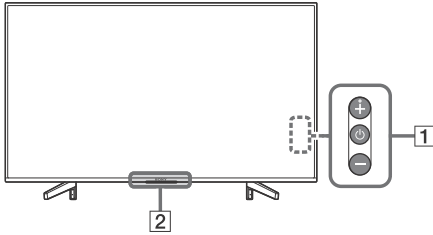



1 (Power) / + / -

Short press  to turn the TV on.

Long press  until the TV turn off.

When the TV is on,
Volume

Press + or - button to increase/decrease the volume.

You can also press  until  notification is displayed. Increases/decreases the volume by pressing the + or - button.

Input

Press  until  notification is displayed.

Moves the selected input source by pressing + (up) or - (down) button.

Programme

Press  until **PROG** notification is displayed.

Select the programme by pressing + (up) or - (down) button.

2 (Sensors/LED indicator)

- Receives signals from the remote control. Do not put anything over the sensor. Doing so may affect its function.
- Lights up in amber when the [Sleep Timer]* or [On Timer]* is set, or the TV is in Photo Frame Mode*.
- Lights up in white when [Power Saving]* is set to [Picture Off]*.
- Lights up in white when the TV is turned on.
- Does not light up when the TV is in standby mode.
- Flashes while the remote control is being operated.
- Lights up in red in recording mode.

* For more detailed information, press **HOME** on the remote control, then select [Help Guide] under [Settings] menu.

Note

- Make sure that the TV is completely turned off before unplugging the AC power cord (mains lead).
- To disconnect the TV from the AC power (mains) completely, pull the plug from the AC power outlet (mains socket).
- Please wait for a while when perform input selection to change to other input.

Remote Control

The remote control shape, location, availability and function of remote control buttons may vary depending on your region/country/TV model.

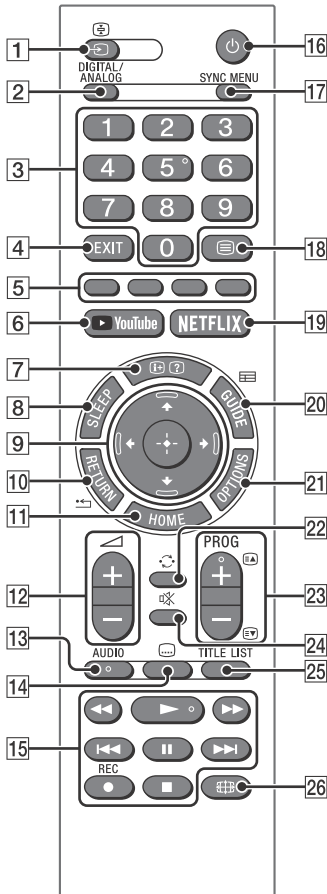

- 1** **(Input select / Text hold)**
- Displays and selects the input source.
 - In text mode, holds the current page.

- 2** **DIGITAL/ANALOG**
- Switches to digital or analogue input.

- 3** **Number buttons**
- Select channels. For channel numbers 10 and above, enter the next digit quickly.
 - In text mode, enter the three digit page number to select the page.

- 4** **EXIT**
- Return to the previous screen or exit from the menu. When an Interactive Application service is available, press to exit from the service.

- 5** **Colour buttons**
- Displays operation guide (when colour buttons are available).

- 6** **YouTube (Only on limited region/country/TV model)**
- Accesses the "YouTube" online service.

- 7** **(Info / Text reveal)**
- Displays information. Press once to display information about the programme/input you are viewing. Press again to remove the display from the screen.
 - In text mode, reveals hidden information (e.g. answers to a quiz).

- 8** **SLEEP**
- Press repeatedly until the TV displays the time in minutes ([Off]/[15 min]/[30 min]/[45 min]/[60 min]/[90 min]/[120 min]) that you want the TV to remain on before shutting off. To cancel the sleep timer, press **SLEEP** repeatedly until [Off] appears.

- 9** **(Item select / Enter)**
- Select or adjust items.
 - Confirm selected items.

- 10** **RETURN**
- Returns to the previous screen of any displayed menu.
 - Stops playback when playing photo/music/video file.

- 11** **HOME**
- Displays or cancels the menu.

12  +/- (Volume)

Adjusts the volume.

13 **AUDIO**

Select the sound of multilingual source or dual sound for the programme currently being viewed (Depend on programme source).

14  (Subtitle)

Changes the subtitle setting.

15 

- Operate media contents on the TV and connected BRAVIA Sync-compatible device.
- This key also can be used to operate VOD (Video on Demand) service playback. Availability is depend on VOD service.

● **REC (Australia and New Zealand model only)**

Record the current programme with the USB HDD recording function.

 (Except Australia and New Zealand model)

Replays the scene/briefly fast forwards the scene.

16  (TV standby)

Turns the TV on or switches to standby mode.

17 **SYNC MENU**

Press to display the BRAVIA Sync Menu and then select connected HDMI equipment from [Device Selection].

The following options can be selected from BRAVIA Sync Menu.

Device Control:

Use the [Device Control] to operate equipment that is compatible with BRAVIA Sync Control. Select options from [Home (Menu)], [Options], [Content List] and [Power Off] to operate the equipment.

Speakers:

Select [TV Speakers] or [Audio System] to output the TV's sound from the TV speakers or connected audio equipment.

TV Control:

Use the [TV Control] menu to operate the TV from the [Home (Menu)] or [Options] menu.

Return to TV:

Select this option to return to the TV programme.

18  (Text)

In text mode, displays Text broadcast.

Each time you press , the display changes cyclically as follows:

Text → Text over the TV picture (mix mode) →

No Text (exit the Text service)

19 **NETFLIX (Only on limited region/country/TV model)**

Accesses the "NETFLIX" online service.

20  **GUIDE (EPG)**

Displays the Digital EPG (Electronic Programme Guide).



21 **OPTIONS**



Displays a list that contains shortcuts to some setting menus.

The listed options vary depending on the current input and content.

22  (Jump)

Returns to the previous channel or input viewed more than 15 seconds.

23 **PROG +/-**  

- Selects the next (+) or previous (-) channel.
- In text mode, selects the next () or previous () page.

24  (Mute)

Mutes the sound. Press again to restore the sound.

25 **TITLE LIST (Australia and New Zealand model only)**

Display the Title list.

26  (Wide Mode)

Adjusts the screen display. Press repeatedly to select the desired wide mode.

Hint

The number **5**, , **PROG +** and **AUDIO** buttons have tactile dots. Use the tactile dots as references when operating the TV.

Connecting TV to the Internet



Setting up the Internet Connection

To use the network features of your TV it needs to be connected to the Internet.

HOME → [System Settings] → [Setup] → [Network] → [Network Setup].

For more detailed information, press **HOME** on the remote control, then select [Help Guide] under [Settings] menu.

Watching TV

- 1 Press  on the TV or the remote control to turn on the TV.
- 2 Press **DIGITAL/ANALOG** to switch between digital and analogue inputs.
- 3 Press the number buttons or **PROG +/-** to select a TV channel.
- 4 Press  +/- to adjust the volume.

Viewing Pictures from Connected Equipment

Connection Diagram

You can connect a wide range of optional equipment to your TV.

Note

- Depending on TV model, connecting a large USB device may interfere with other connected devices beside it.
- When connecting a large USB device, connect only 1 USB jack.

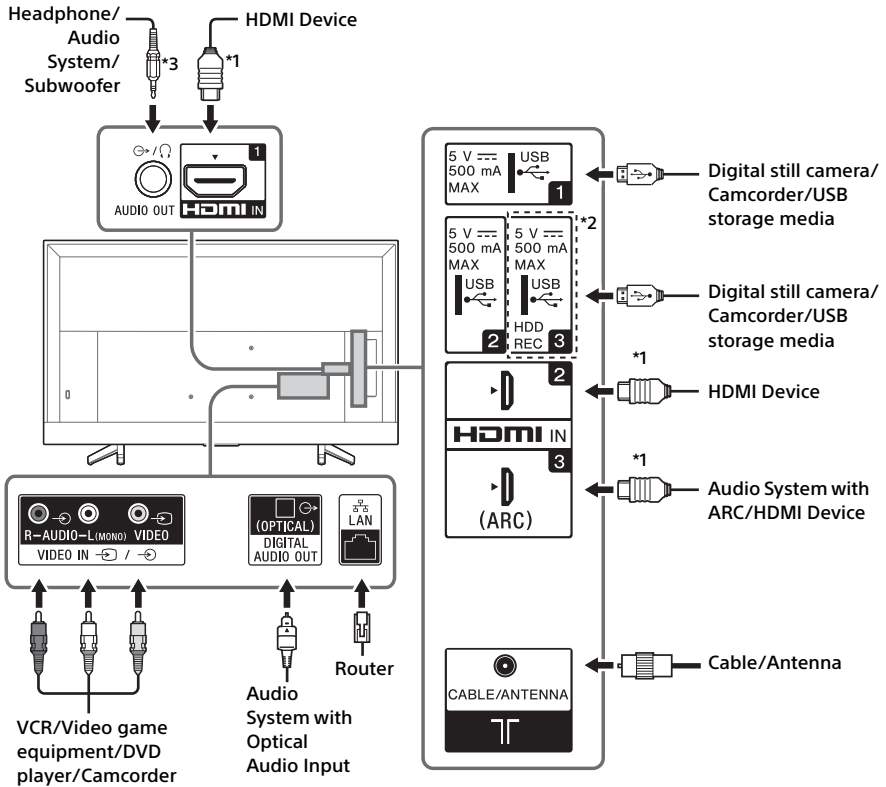

Note

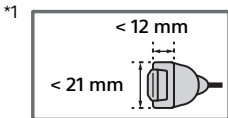

*2 Terminals and labels may vary depending on region/country/TV model.

*3 Supports 3-pole stereo mini jack only.

Additional Information

Installing the TV to the Wall

This TV's instruction manual only provides the steps to prepare the TV for Wall-Mount installation before it is installed on the wall.

To Customers:

For product protection and safety reasons, Sony strongly recommends that installation of your TV be performed by Sony dealers or licensed contractors. Do not attempt to install it yourself.

To Sony Dealers and Contractors:

Provide full attention to safety during the installation, periodic maintenance and examination of this product.

Sufficient expertise is required for installing this product, especially to determine the strength of the wall for withstanding the TV's weight. Be sure to entrust the attachment of this product to the wall to Sony dealers or licensed contractors and pay adequate attention to safety during the installation. Sony is not liable for any damage or injury caused by mishandling or improper installation.

Use the Wall-Mount Bracket SU-WL450 (not supplied) to install the TV to the wall.

When installing the Wall-Mount Bracket, also refer to the Operating Instructions and Installation Guide supplied with the Wall-Mount Bracket.

Note

- Be sure to store the removed screws in a safe place, keeping them away from children.
- Place the TV with its screen facing down on a level and stable surface covered with a thick and soft cloth when removing the Table-Top Stand from the TV to prevent damaging the surface of the LCD display (KD-49X7077F, KD-49/43X7000F only).

To detach the Table-Top Stand from the TV

KD-49X7077F, KD-49/43X7000F

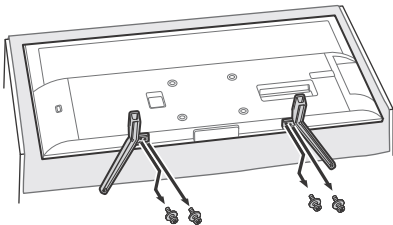

- 1** Make sure that the wall has enough space for the TV and is capable of supporting a weight of at least four times that of the TV. Refer to the following table on installing the TV to the wall. See page 18-19 (Specifications) for the TV's weight.

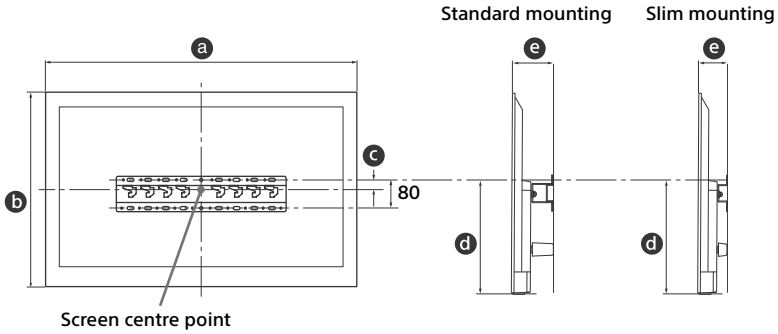

Unit: mm

Model Name	Display dimensions		Screen centre dimension	Length for mounting		
	a	b	c	d	Standard mounting	Slim mounting
KD-65X7000F	1,461	844	26	460	142	100
KD-55X7077F KD-55X7000F	1,242	721	95	460	142	100
KD-49X7077F KD-49X7000F	1,101	645	15	314	120	78
KD-43X7000F	970	571	23	315	120	78

Note

- Figures in the table may differ slightly depending on the installation.
- When your TV is installed on the wall, the upper side of the TV slightly leans forward.

- 2** Attach the Attachment parts for Wall-Mount Bracket. Check the Attachment parts by referring to "1" of the Wall-Mount Bracket Installation Guide.

Note

- If using an electric screwdriver, set the torque at approximately 1.5 N·m (15 kgf·cm).
- Be sure to store the unused parts in a safe place for future use. Retain this manual for future reference.

Standard mounting

KD-65/55X7000F, KD-55X7077F

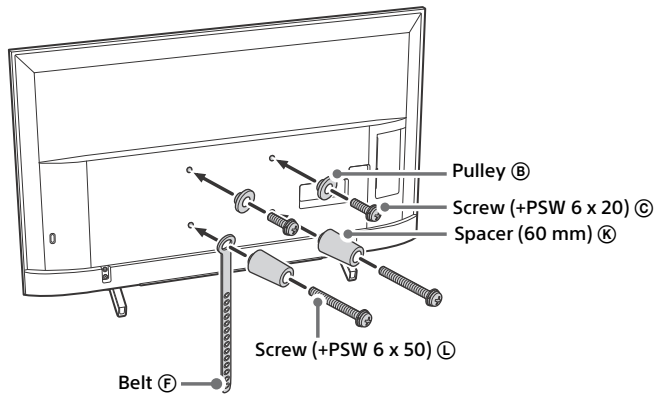

KD-49X7077F, KD-49/43X7000F

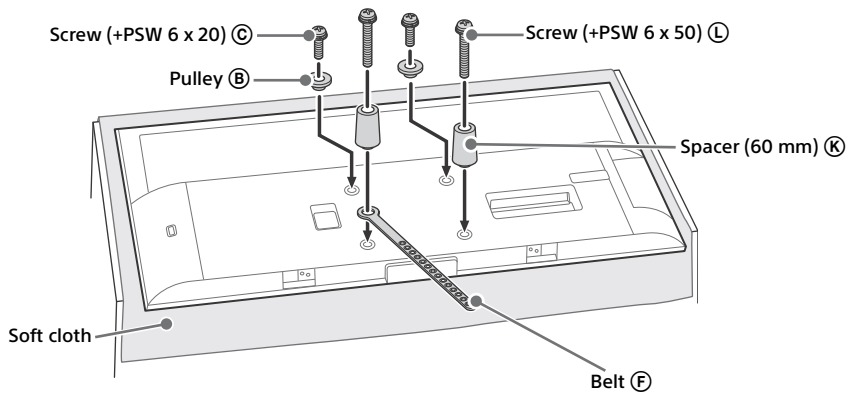

Slim mounting

Note

- You cannot use some of the terminals on the rear of the TV when using this mounting style.

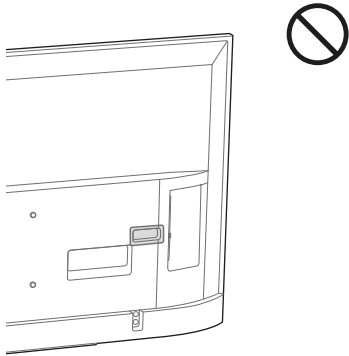

KD-65/55X7000F, KD-55X7077F

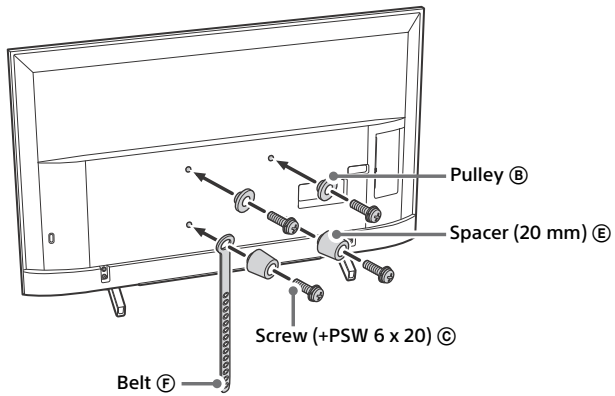

KD-49X7077F, KD-49/43X7000F

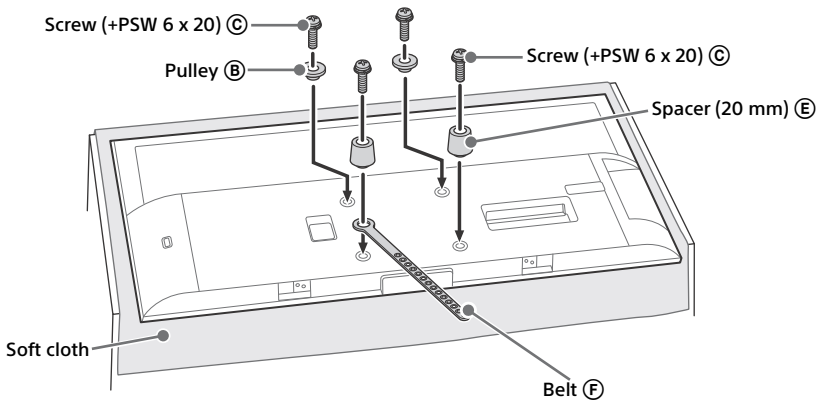

3 Connect necessary cables to the TV.

Note

- You cannot access to any terminal after installing the TV to the wall.

4 To detach the Table-Top Stand from the TV.

KD-65/55X7000F, KD-55X7077F

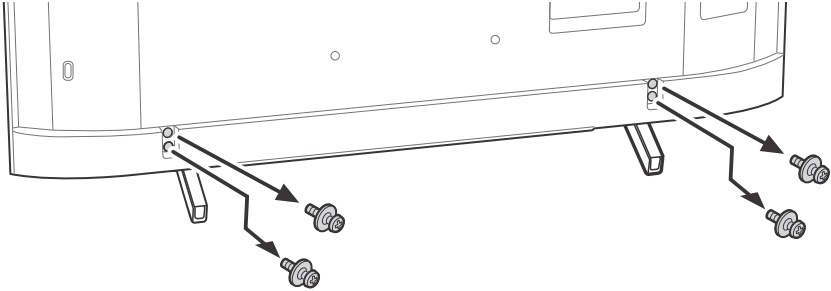

5 Install the TV to the Base. Refer to "5" of Installation Guide and "Installing the TV to the Wall" of Operating Instructions supplied with the Wall-Mount Bracket.

Model Name	Hook location
KD-65X7000F	b
KD-55X7077F KD-55X7000F KD-49X7077F KD-49X7000F	c
KD-43X7000F	d

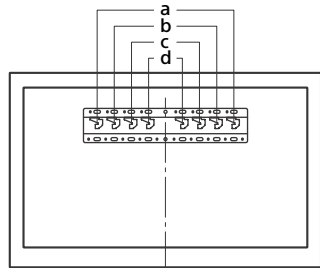

Refer to the instructions supplied with the Wall-Mount Bracket for your model to install the TV on the wall.

Troubleshooting

When the LED indicator is flashing red, count how many times it flashes (interval time is three seconds).

If the LED indicator flashes red, reset the TV by disconnecting the AC power cord (mains lead) from the TV for two minutes, then turn on the TV.

If the problem persists, contact your dealer or Sony service centre with the number of times the LED indicator flashes red (interval time is three seconds). Press \odot on the TV to turn it off, disconnect the AC power cord (mains lead), and inform your dealer or Sony service centre.

When the LED indicator is not flashing, check the items as follows.

If the problem persists, have your TV serviced by qualified service personnel.

Picture

No picture (screen is dark) and no sound

- Check the antenna (aerial)/cable connection.
- Connect the TV to the AC power outlet (mains socket), and press \odot on the TV or the remote control.

Double images or ghosting

- Check the antenna (aerial)/cable connection, location or direction.

Only snow and noise appear on the screen

- Check if the antenna is broken or bent.
- Check if the antenna has reached the end of its serviceable life (three to five years in normal use, one to two years at the seaside).

Distorted picture (dotted lines or stripes)

- Keep the TV away from electrical noise sources such as cars, motorcycles, hair-dryers or optional equipment.
- When installing optional equipment, leave some space between the optional equipment and the TV.
- Check the antenna (aerial)/cable connection.
- Keep the antenna cable away from other connecting cables.

Picture or sound noise when viewing a TV channel

- Adjust [AFT] (Automatic Fine Tuning) to obtain better picture reception. This function is for analogue TV channels only.

Picture contours are distorted

- Change the current setting of [Film Mode]* to other settings.

General

The TV turns off automatically (the TV enters standby mode)

- Check if the [Sleep Timer]* is activated.
- Check if the [Duration]* is activated by [On Timer]* or [Photo Frame Settings]*.
- Check if the [Idle TV Standby]* is activated.

Some input sources cannot be selected

- Select [Video Labels]* and select [Always]* of the input source.

The remote control does not function

- Replace the batteries.

* For more detailed information, press **HOME** on the remote control, then select [Help Guide] under [Settings] menu.

Specifications

System

Panel system

LCD (Liquid Crystal Display) Panel, LED backlight

TV system

Depend on your country/area selection

Analogue: B/G, I, D/K, M

Digital: DVB-T/DVB-T2

Colour/video system

Analogue: PAL/SECAM/NTSC3.58/NTSC4.43

Digital: MPEG-2 MP@ML/HL, H.264/MPEG-4 AVC

HP/MP@L5.0, H.265/HEVC MP/Main10@L5.1

(4K 60fps)

Channel coverage

Depend on your country/area selection

Analogue: UHF/VHF/Cable

Digital: UHF/VHF

Sound output

10 W + 10 W

Wireless technology

Protocol IEEE802.11b/g/n

Input/Output jacks

Antenna (aerial)/cable

75 ohm external terminal for VHF/UHF

VIDEO IN

Video input (phono jack)

AUDIO IN

Audio input (phono jacks)

HDMI IN 1/2/3 (ARC) (Support 4K resolution,

HDCP 2.3-compatible)

HDMI Video: 4096 × 2160p (24, 50, 60 Hz),

3840 × 2160p (24, 25, 30, 50, 60 Hz), 1080p (30,

50, 60 Hz), 1080/24p, 1080i (50, 60 Hz), 720p (30,

50, 60 Hz), 720/24p, 576p, 576i, 480p, 480i

*HDMI IN 2 and HDMI IN 3 support High-Quality HDMI

formats such as 4K 60p/50p 4:2:0 10 bit, 4:4:4,

4:2:2.

PC input: (Resolution (Horizontal frequency,

Vertical frequency))

640 × 480 (31.5 kHz, 60 Hz),

800 × 600 (37.9 kHz, 60 Hz),

1,024 × 768 (48.4 kHz, 60 Hz),

1,280 × 1,024 (64.0 kHz, 60 Hz),

1,152 × 864 (67.5 kHz, 75 Hz),

1,600 × 900 (55.9 kHz, 60 Hz),

1,680 × 1,050 (65.3 kHz, 60 Hz),

1,920 × 1,080 (67.5 kHz, 60 Hz)*

* The 1080p timing when applied to the HDMI input will be treated as a video timing and not PC timing for Wide mode.

Audio:

Two channel linear PCM: 32/44.1/48 kHz 16/20/

24 bits, Dolby Digital, Dolby Digital Plus, DTS

ARC (Audio Return Channel) (HDMI IN 3 only)

Two channel linear PCM: 48 kHz 16 bits, Dolby

Digital, Dolby Digital Plus, DTS

DIGITAL AUDIO OUT (OPTICAL)

Digital optical jack (Two channel linear PCM:

48 kHz 16 bits, Dolby Digital, DTS)

AUDIO OUT (Stereo mini jack)

Headphone, Audio output, Subwoofer

1, 2, 3 (except Australia and New Zealand model)

USB port

1, 2, 3 (HDD REC) (Australia and New Zealand model only)

USB port

DC IN 19.5 V (models with supplied AC adapter only)

AC adapter input

LAN

10BASE-T/100BASE-TX connector (Depending on the operating environment of the network, connection speed may differ. 10BASE-T/100BASE-TX communication rate and communication quality are not guaranteed for this TV.)

Others

Optional accessories

Wall-Mount Bracket: SU-WL450

Operating temperature

0 °C – 40 °C

Power and others

Power requirements

except models with supplied AC adapter

110 V - 240 V AC, 50/60 Hz

models with supplied AC adapter only

19.5 V DC with AC adapter

Rating: Input 100 V - 240 V AC, 50/60 Hz

Energy Efficiency Class*1

(For Jordan only)

KD-65X7000F: A+

KD-55X7077F / KD-55X7000F: A

KD-49X7077F / KD-49X7000F: A

(For Egypt only)

KD-65X7000F: A

KD-55X7000F: B

KD-49X7000F: A

KD-43X7000F: A

Screen size (measured diagonally) (approx.)

KD-65X7000F: 65 inches / 163.9 cm
KD-55X7077F / KD-55X7000F: 55 inches / 138.8 cm
KD-49X7077F / KD-49X7000F: 49 inches /
123.2 cm
KD-43X7000F: 43 inches / 108.0 cm

Power consumption

Indicated on the rear of the TV

Power consumption*¹

In [Standard] mode
(For Jordan only)

KD-65X7000F: 106 W
KD-55X7077F / KD-55X7000F: 109 W
KD-49X7077F / KD-49X7000F: 75 W
KD-43X7000F: 63 W

(For Egypt only)

KD-65X7000F: 103.0 W
KD-55X7000F: 107.0 W
KD-49X7000F: 73.0 W
KD-43X7000F: 62.0 W

In [Vivid] mode

KD-65X7000F: 171 W
KD-55X7077F / KD-55X7000F: 172 W
KD-49X7077F / KD-49X7000F: 100 W
KD-43X7000F: 95 W

Average annual energy consumption*¹

(For Jordan only)*²

KD-65X7000F: 155 kWh
KD-55X7077F / KD-55X7000F: 159 kWh
KD-49X7077F / KD-49X7000F: 110 kWh
KD-43X7000F: 92 kWh

(For Egypt only)*³

KD-65X7000F: 297 kWh
KD-55X7000F: 309 kWh
KD-49X7000F: 211 kWh
KD-43X7000F: 179 kWh

Standby power consumption*^{1,4,5}

0.50 W

Display resolution

3,840 dots (horizontal) × 2,160 lines (vertical)

Dimensions (Approx.) (w × h × d)

with Table-Top Stand

KD-65X7000F: 1,461 × 907 × 355 mm
KD-55X7077F / KD-55X7000F: 1,242 × 784 ×
356 mm
KD-49X7077F / KD-49X7000F: 1,101 × 705 ×
279 mm
KD-43X7000F: 970 × 630 × 278 mm

without Table-Top Stand

KD-65X7000F: 1,461 × 844 × 80 mm
KD-55X7077F / KD-55X7000F: 1,242 × 721 × 80 mm
KD-49X7077F / KD-49X7000F: 1,101 × 645 × 58 mm
KD-43X7000F: 970 × 571 × 58 mm

Mass (Approx.)

with Table-Top Stand

KD-65X7000F: 21.4 kg
KD-55X7077F / KD-55X7000F: 17.4 kg
KD-49X7077F / KD-49X7000F: 12.6 kg
KD-43X7000F: 10.4 kg

without Table-Top Stand

KD-65X7000F: 20.2 kg
KD-55X7077F / KD-55X7000F: 16.2 kg
KD-49X7077F / KD-49X7000F: 12 kg
KD-43X7000F: 9.8 kg

*¹ This information is for EU and other countries whose relevant regulation is based on EU energy labelling regulation.

*² Energy consumption per year, based on the power consumption of the television operating 4 hours per day for 365 days. The actual energy consumption will depend on how the television is used.

*³ Energy consumption per year, based on the power consumption of the television operating 8 hours per day for 360 days. The actual energy consumption will depend on how the television is used.

*⁴ Specified standby power is reached after the TV finishes necessary internal processes.

*⁵ Standby power consumption will increase when your TV is connected to the network.

Note

- Optional accessories availability depends on countries/region/TV model/stock.
- Design and specifications are subject to change without notice.

Notes on Digital TV function

- Any functions related to Digital TV (**DVB**) will only work in countries or areas where DVB-T/DVB-T2 (MPEG-2 and H.264/MPEG-4 AVC) digital terrestrial signals are broadcast. Please confirm with your local dealer if you can receive a DVB-T/DVB-T2 signal where you live.
- This TV set complies with DVB-T/DVB-T2 specifications, but compatibility with future DVB-T/DVB-T2 digital terrestrial broadcasts are not guaranteed.
- Some Digital TV functions may not be available in some countries/areas.

Notes on HDR (High Dynamic Range) (Only on limited region/country/TV model)

- Compatible with all HDR PS4 Game titles via HDMI and HDR videos of built-in Netflix and YouTube App only. (See Sony support website for more information).
- HDR image signal specifically means HDR10 Media Profile format (commonly referred to as HDR10).
- Compatibility with all HDR content is not guaranteed.

Trademark information

- The terms HDMI and HDMI High-Definition Multimedia Interface, and the HDMI Logo are trademarks or registered trademarks of HDMI Licensing Administrator, Inc. in the United States and other countries.
- Manufactured under license from Dolby Laboratories. Dolby, Dolby Audio, and the double-D symbol are trademarks of Dolby Laboratories.
- Vewd® Core. Copyright 1995-2017 Vewd Software AS. All rights reserved.
- Wi-Fi®, Wi-Fi Alliance®, Wi-Fi Direct® and Miracast® are registered trademarks of Wi-Fi Alliance.
- Wi-Fi Protected Setup™ is a trademark of Wi-Fi Alliance.
- The Wi-Fi CERTIFIED™ Logo is a certification mark of Wi-Fi Alliance.
- Netflix is a registered trademark of Netflix, Inc.
- “YouTube” and the “YouTube logo” are registered trademarks of Google LLC.
- “BRAVIA”, BRAVIA and BRAVIA Sync are trademarks or registered marks of Sony Corporation.
- “Blu-ray Disc”, “Blu-ray” and “Blu-ray Disc” logo are trademarks of Blu-ray Disc Association.
- “PlayStation” is a registered trademark and “PS4” is a trademark of Sony Interactive Entertainment Inc.

- For DTS patents, see

under license from DTS, Inc. DTS, the Symbol, & DTS and the Symbol together are registered trademarks, and DTS Digital Surround is a trademark of DTS, Inc. © DTS, Inc. All Rights Reserved.

- TUXERA is a registered trademark of Tuxera Inc. in the US and other countries.
- All other trademarks are the property of their respective owners.



Actual resolution:
3840 x 2160 pixels