



# Refrigerator

User manual (freezer only)

RZ32M\*

Free Standing Appliance

**SAMSUNG**

# Contents

---

|   |           |
|---|-----------|
| <b>Safety information</b>   | <b>3</b>  |
| Important safety symbols and precautions:   | 5         |
| Severe warning signs for transportation and site                                    | 6         |
| Critical installation warnings  | 6         |
| Installation cautions   | 10        |
| Critical usage warnings   | 10        |
| Usage warning   | 15        |
| Usage cautions  | 16        |
| Cleaning cautions   | 18        |
| Critical disposal warnings  | 19        |
| Additional tips for proper usage  | 20        |
| Saving Energy Tips  | 21        |
| This appliance is intended to be used in household and similar applications such as | 22        |
| Instructions about the WEEE   | 23        |
| <br>  |           |
| <b>Installation</b>   | <b>24</b> |
| Refrigerator at a glance  | 24        |
| Step-by-step installation   | 25        |
| <br>  |           |
| <b>Operations</b>   | <b>32</b> |
| Feature panel   | 32        |
| Samsung Smart Home  | 35        |
| Special features  | 37        |
| <br>  |           |
| <b>Maintenance</b>  | <b>42</b> |
| Door reversal (applicable models only)  | 42        |
| Handle and care   | 59        |
| Cleaning  | 62        |
| Replacement   | 62        |
| <br>  |           |
| <b>Troubleshooting</b>  | <b>63</b> |
| General   | 63        |
| Do you hear abnormal sounds from the refrigerator?                                  | 65        |
| Samsung Smart Home  | 67        |

## Safety information

---

- Before using your new Samsung Refrigerator, please read this manual thoroughly to ensure that you know how to operate the features and functions that your new appliance offers safely and efficiently.
- This appliance is not intended for use by persons (including children) with reduced physical, sensory, or mental capabilities, or those who lack experience and knowledge, unless they have been given supervision or instruction concerning the use of the appliance by a person responsible for their safety.
- This appliance can be used by children aged from 8 years and above and persons with reduced physical, sensory or mental capabilities or lack of experience and knowledge if they have been given supervision or instruction concerning use of the appliance in a safe way and understand the hazards involved.  
Children shall not play with the appliance. Cleaning and user maintenance shall not be made by children without supervision.
- Warnings and Important Safety Instructions in this manual do not cover all possible conditions and situations that may occur.  
It is your responsibility to use common sense, caution, and care when installing, maintaining, and operating your appliance.

## Safety information

---

- Because these following operating instructions cover various models, the characteristics of your refrigerator may differ slightly from those described in this manual and not all warning signs may be applicable. If you have any questions or concerns, contact your nearest service center or find help and information online at [www.samsung.com](http://www.samsung.com).
- In order to avoid the creation of a flammable gas-air mixture if a leak in the refrigerating circuit occurs, the size of the room in which the appliance may be sited depends on the amount of refrigerant used.
- Never start up an appliance showing any signs of damage. If in doubt, consult your dealer. The room must be 1 m<sup>3</sup> in size for every 8 g of R-600a refrigerant inside the appliance. The amount of refrigerant in your particular appliance is shown on the identification plate inside the appliance.
- Refrigerant squirting out of the pipes could ignite or cause an eye injury. When refrigerant leaks from the pipe, avoid any naked flames and move anything flammable away from the product and ventilate the room immediately.
  - Failing to do so may result in fire or explosion.
- It is hazardous for anyone other than an Authorised Service Person to service this appliance.
- Do not store explosive substances such as aerosol cans with a flammable propellant in this appliance.

---

## Important safety symbols and precautions:

---

Please follow all safety instructions in this manual. This manual uses the following safety symbols.

### **WARNING**

Hazards or unsafe practices that may result in **severe personal injury, property damage, and/or death.**

### **CAUTION**

Hazards or unsafe practices that may result in **severe personal injury and/or property damage.**

### **NOTE**

Useful information that helps users understand or benefit from the refrigerator.

These warning signs are here to prevent injury to you and others.

Please follow them carefully.

After reading this section, keep it in a safe place for future reference.

# Safety information

---

## Severe warning signs for transportation and site

---

### **WARNING**

- When transporting and installing the appliance, care should be taken to ensure that no parts of the refrigerating circuit are damaged.
  - Refrigerant leaking from the pipe work could ignite or cause an eye injury. If a leak is detected, avoid any naked flames or potential sources of ignition and air the room in which the appliance is standing for several minutes.
  - This appliance contains a small amount of isobutane refrigerant (R-600a), a natural gas with high environmental compatibility that is, however, also combustible. When transporting and installing the appliance, care should be taken to ensure that no parts of the refrigerating circuit are damaged.

## Critical installation warnings

---

### **WARNING**

- Do not install the refrigerator in a damp location or place where it may come in contact with water.
  - Deteriorated insulation on electrical parts may cause an electric shock or fire.
- Do not place this refrigerator in direct sunlight or expose it to the heat from stoves, room heaters, or other appliances.

- Do not plug several appliances into the same multiple power strip. The refrigerator should always be plugged into its own individual electrical outlet which has a voltage rating that matches the voltage listed on the refrigerator's rating plate.
  - This provides the best performance and also prevents overloading of house wiring circuits, which could cause a fire hazard from overheated wires.
- If the wall socket is loose, do not insert the power plug.
  - There is a risk of electric shock or fire.
- Do not use a power cord that has cracks or abrasion damage along its length or at either end.
- Do not bend the power cord excessively or place heavy objects on it.
- Do not pull or excessively bend the power cord.
- Do not twist or tie the power cord.
- Do not hook the power cord over a metal object, place a heavy object on the power cord, insert the power cord between objects, or push the power cord into the space behind the appliance.
- When moving the refrigerator, be careful not to roll over or damage the power cord.
  - This may result in an electric shock or fire.
- Never unplug your refrigerator by pulling on the power cord. Always grip the plug firmly and pull straight out from the outlet.
  - Damage to the cord may cause a short-circuit, fire, and/or electric shock.
- Do not store explosive substances such as aerosol cans with a flammable propellant in this appliance.

## Safety information

---

- Do not install this appliance near a heater or inflammable material.
- Do not install this appliance in a location where gas may leak.
  - This may result in an electric shock or fire.
- This refrigerator must be properly located and installed in accordance with the instructions in this manual before you use it.
- Connect the power plug in the proper position with the cord hanging down.
  - If you connect the power plug upside down, the wire can get cut off and cause a fire or electric shock.
- Make sure that the power plug is not crushed or damaged by the back of the refrigerator.
- Keep the packing materials out of reach of children.
  - There is a risk of death from suffocation if a child puts the packing materials on his or her head.
- The appliance must be positioned so that the plug is accessible after installation.
  - Failing to do so may result in an electric shock or fire due to electric leakage.
- Do not install this appliance in a humid, oily or dusty location, in a location exposed to direct sunlight and water (rain drops).
  - Deteriorated insulation of electrical parts may cause an electric shock or fire.
- If any dust or water is in the refrigerator, pull out power plug and contact your Samsung Electronics service center.
  - Otherwise there is a risk of fire.



- 
- Do not stand on top of the appliance or place objects (such as laundry, lighted candles, lighted cigarettes, dishes, chemicals, metal objects, etc.) on the appliance.
    - This may result in an electric shock, fire, problems with the product, or injury.
  - You need to remove all the protective plastic film before you initially plug the product in.
  - The refrigerator must be safely grounded.
    - Always make sure that you have grounded the refrigerator before attempting to investigate or repair any part of the appliance. Power leakages can cause severe electric shock.
  - Never use gas pipes, telephone lines, or other potential lightning attractors as an electrical ground.
    - You must ground the refrigerator to prevent any power leakages or electric shocks caused by current leakage from the refrigerator.
    - This may result in an electric shock, fire, explosion, or problems with the product.
  - Plug the power plug into the wall socket firmly. Do not use a damaged power plug, damaged power cord, or loose wall socket.
    - This may result in an electric shock or fire.
  - If the power cord is damaged, have it replaced immediately by the manufacturer or one of its service agents.
  - The fuse on the refrigerator must be changed by a qualified technician or service company.
    - Failing to do so may result in an electric shock or personal injury.

# Safety information

---

## Installation cautions

---

### CAUTION

- Allow sufficient space around the refrigerator and install it on a flat surface.
  - Keep the ventilation space in the appliance enclosure or mounting structure clear of obstructions.
- Allow the appliance to stand for 2 hours before loading foods after installation and turning on.
- We strongly recommend you have a qualified technician or service company install the refrigerator.
  - Failing to do so may result in an electric shock, fire, explosion, problems with the product, or injury.
- Overload on any one door may fell the refrigerator, causing physical injury.

## Critical usage warnings

---

### WARNING

- Do not insert the power plug into a wall socket with wet hands.
  - This may result in an electric shock.
- Do not store articles on the top of the appliance.
  - When you open or close the door, the articles may fall and cause personal injury and/or material damage.
- Do not insert hands, feet or metal objects (such as chopsticks, etc.) into the bottom or the back of the refrigerator.
  - This may result in an electric shock or injury.

- 
- Any sharp edges may cause a personal injury.
  - Do not touch the inside walls of the freezer or products stored in the freezer with wet hands.
    - This may cause frostbite.
  - Do not put a container filled with water on the refrigerator.
    - If spilled, there is a risk of fire or electric shock.
  - Do not keep volatile or flammable objects or substances (benzene, thinner, propane gas, alcohol, ether, LP gas, and other such products) in the refrigerator.
    - This refrigerator is for storing food only.
    - This may result in fire or explosion.
  - Children should be supervised to ensure that they do not play with the appliance.
    - Keep fingers out of “pinch point” areas. Clearances between the doors and cabinet are necessarily small. Be careful when you open the doors if children are in the area.
  - Do not let children hang on the door or door bins. A serious injury may occur.
  - Do not let children go inside the refrigerator. They could become trapped.
  - Do not insert your hands into the bottom area under the appliance.
    - Any sharp edges may cause personal injury.
  - Do not store pharmaceutical products, scientific materials, or temperature sensitive products in the refrigerator.
    - Products that require strict temperature controls must not be stored in the refrigerator.

## Safety information

---

- Do not place or use electrical appliance inside the refrigerator/freezer, unless they are of a type recommended by the manufacturer.
- If you smell pharmaceutical or smoke, pull out power plug immediately and contact your Samsung Electronics service center.
- If any dust or water is in Refrigerator, pull out power plug and contact your Samsung Electronics service center.
  - Otherwise there is a risk of fire.
- Do not let children step on a drawer.
  - The drawer may break and cause them to slip.
- Do not leave the doors of the refrigerator open while the refrigerator is unattended and do not let children enter inside the refrigerator.
- Do not allow babies or children go inside the drawer.
  - It can cause death from suffocation by entrapment or personal injury.
- Do not overfill the refrigerator with food.
  - When you open the door, an item may fall out and cause personal injury or material damage.
- Do not spray volatile material such as insecticide onto the surface of the appliance.
  - As well as being harmful to humans, it may also result in an electric shock, fire, or problems with the product.
- Do not use or place any substances sensitive to temperature such as flammable sprays, flammable objects, dry ice, medicine, or chemicals near or inside of the refrigerator.

- 
- Do not use a hair dryer to dry the inside of the refrigerator. Do not place a lighted candle in the refrigerator for removing bad odours.
    - This may result in an electric shock or fire.
  - Do not stand on top of the appliance or place objects (such as laundry, lighted candles, lighted cigarettes, dishes, chemicals, metal objects, etc.) on the appliance. This may result in an electric shock, fire, problems with the product, or injury. Do not put a container filled with water on the appliance.
    - If spilled, there is a risk of fire or electric shock.
  - Do not use mechanical devices or any other means to accelerate the defrosting process, other than those recommended by the manufacturer.
  - Do not damage the refrigerant circuit.
  - Never stare directly at the UV LED lamp for long periods of time.
    - This may result in eye strain due to the ultraviolet rays.
  - Do not put freezer shelf in upside down. Shelf stopper could not work.
    - It may cause a personal injury because of glass shelf drop.
  - Keep fingers out of “pinch point” areas. Clearances between the doors and cabinet are necessarily small. Be careful when you open the doors if children are in the area.
  - If a gas leak is detected, avoid any naked flames or potential sources of ignition, and air the room in which the appliance is standing for several minutes.
    - Do not touch the appliance or power cord.
    - Do not use a ventilating fan.

## Safety information

---

- A spark may result in explosion or fire.
- Use only the LED Lamps provided by the manufacturer or its service agents.
- Bottles should be stored tightly together so that they do not fall out.
- This product is intended only for the storage of food in a domestic environment.
- Do not attempt to repair, disassemble, or modify the refrigerator yourself.
  - Unauthorized modifications can cause safety problems. To reverse an unauthorized modification, we will charge the full cost of parts and labor.
- Do not use any fuse (such as cooper, steel wire, etc.) other than a standard fuse.
- If your refrigerator needs to be repaired or reinstalled, contact your nearest service center.
  - Failing to do so may result in an electric shock, fire, problems with the product, or injury.
- If the interior or exterior LED lamp has gone out, contact your nearest service center.
- If the refrigerator emits a burning smell or smoke, unplug the refrigerator immediately and contact your Samsung Electronics service center.
  - Failing to do so may result in an electric or fire hazards.
- Pull the power plug out of the socket before changing the interior lamps of the refrigerator.
  - Otherwise, there is a risk of electric shock.
- If you experience difficulty changing a non-LED light, contact a Samsung service center.

- 
- If the product is equipped with LED lamps, do not disassemble the Lamp Covers and LED lamps yourself.
    - Contact a Samsung service center.
  - Plug the power plug into the wall socket firmly.
  - Do not use a damaged power plug, damaged power cord or loose wall socket.
    - This may result in an electric shock or fire.

## Usage warning

---

### **WARNING**

- Keep ventilation openings, in the appliance enclosure or in the built-in structure, clear of obstruction.
- Do not use mechanical devices or other means to accelerate the defrosting process, other than those recommended by the manufacturer.
- Do not damage the refrigerant circuit.
- Do not use electrical appliances inside the food storage compartments of the appliance, unless they are of the type recommended by the manufacturer.

# Safety information

---

## Usage cautions

---

### CAUTION

- Do not re-freeze frozen foods that have thawed completely. Do not place carbonated or fizzy drinks in the freezer compartment. Do not put bottles or glass containers in the freezer.
  - When the contents freeze, the glass may break and cause personal injury.
- To get the best performance from the product:
  - Do not place food too close to the vents at the rear of the refrigerator as this can obstruct free air circulation in the refrigerator compartment.
  - Wrap food up properly or place it in airtight containers before putting it into the refrigerator.
  - Do not place glass bottles or carbonated beverages into the freezer. They can freeze and break. Broken beverage containers can cause injury.
  - Please observe maximum storage times and expiration dates of frozen goods.
- Do not place glass or bottles or carbonated beverages into the freezer.
  - The container may freeze and break, and this may result in injury.
- Do not place carbonated or fizzy drinks in the freezer compartment. Do not put bottles or glass containers in the freezer.
  - When the contents freeze, the glass may break and cause personal injury and property damage.



- 
- Service Warranty and Modification.
    - Any changes or modifications performed by a 3rd party on this finished appliance are not covered under Samsung warranty service, nor is Samsung responsible for safety issues that result from 3rd party modifications.
  - Do not block the air vents inside the refrigerator.
    - If the air vents are blocked, especially with a plastic bag, the refrigerator can be over cooled.
  - Wipe excess moisture from the inside and leave the doors open.
    - Otherwise, odor and mold may develop.
  - If the refrigerator is disconnected from the power supply, you should wait for at least five minutes before plugging it back in.
  - When the refrigerator got wet by water, pull out the power plug and contact your Samsung Electronics service center.
  - Do not strike or apply excessive force to any glass surface.
    - Broken glass may result in a personal injury and/or property damage.
  - Be careful that your fingers are not caught in.
  - If the refrigerator is flooded, make sure to contact your nearest service center.
    - There is a risk of electric shock or fire.

# Safety information

---

## Cleaning cautions

---

### CAUTION

- Do not spray water directly on the inside or outside the refrigerator.
  - There is a risk of fire or electric shock.
- Do not use a hair dryer to dry the inside of the refrigerator.
- Do not place a lighted candle in the refrigerator to remove bad odors.
  - This may result in an electric shock or fire.
- Do not spray cleaning products directly on the display.
  - Printed letters on the display may come off.
- If any foreign substance such as water has entered the appliance, unplug the power plug and contact your nearest service center.
  - Failing to do so may result in an electric shock or fire.
- Use a clean, dry cloth to remove any foreign matter or dust from the power plug blades. Do not use a wet or damp cloth when cleaning the plug.
  - Otherwise, there is a risk of fire or electric shock.
- Do not clean the appliance by spraying water directly onto it.
- Do not use benzene, thinner, or Clorox, Chloride for cleaning.
  - They may damage the surface of the appliance and may cause a fire.
- Before cleaning or performing maintenance, unplug the appliance from the wall socket.
  - Failing to do so may result in an electric shock or fire.



---

## Critical disposal warnings

---

### **WARNING**

- Please dispose of the packaging material from this product in an environmentally friendly manner.
- Ensure that none of the pipes on the back of the refrigerator are damaged prior to disposal.
- R-600a or R-134a is used as a refrigerant. Check the compressor label on the rear of the appliance or the rating label inside the freezer to see which refrigerant is used for your refrigerator. If this refrigerator contains flammable gas (Refrigerant R-600a), contact your local authority in regard to safe disposal of this product.
- When disposing of this refrigerator, remove the door/door seals and door latch so that small children or animals cannot become trapped inside. Children should be supervised to ensure that they do not play with the appliance. If trapped inside, a child may get hurt or suffocate to death.
  - If trapped inside, the child may become injury and suffocate to death.
- Cyclopentane is used in the insulation. The gases in the insulation material require a special disposal procedure. Please contact your local authorities in regard to the environmentally safe disposal of this product.
- Keep all packaging materials well out of the reach of children, as packaging materials can be dangerous to children.
  - If a child places a bag over his or her head, the child could suffocate.



# Safety information

---

## Additional tips for proper usage

---

- In the event of a power failure, call the local office of your electric company and ask how long the failure is going to last.
  - Most power failures that are corrected in an hour or two will not affect your refrigerator temperatures. However, you should minimize the number of door openings while the power is off.
  - Should the power failure last more than 24 hours, remove and discard all frozen food.
- The refrigerator might not operate consistently (frozen contents can thaw or temperatures can become too warm in the frozen food compartment) if sited for an extended period of time in a location where ambient air temperatures are constantly below the temperatures for which the appliance is designed.
- In case of particular foods, keeping it under refrigeration can have a bad effect on preservation due to its properties.
- Your appliance is frost free, which means there is no need to manually defrost your appliance. This will be carried out automatically.
- Temperature rise during defrosting complies with ISO requirements. If you want to prevent an undue rise in the temperature of frozen food while the appliance defrosts, wrap the frozen food in several layers of newspaper.
- Do not re-freeze frozen foods that have thawed completely.



---

## Saving Energy Tips

---

- Install the appliance in a cool, dry room with adequate ventilation. Ensure that it is not exposed to direct sunlight and never put it near a direct source of heat (a radiator, for example).
- Not to block any vents and grilles is recommended for energy efficiency.
- Allow warm food to cool down before placing it in the appliance.
- Put frozen food in the refrigerator to thaw. You can then use the low temperatures of the frozen products to cool food in the refrigerator.
- Do not keep the door of the refrigerator open for too long when putting food in or taking food out. The shorter the time the door is open, the less frost build-up you'll have in the freezer.
- It is recommended to install the refrigerator with clearance to the back and sides. This will help reduce power consumption and keep your energy bills lower.
- For the most efficient use of energy, please keep the all inner fittings such as baskets, drawers, shelves on the position supplied by manufacturer.



# Safety information

---

## **This appliance is intended to be used in household and similar applications such as**

---

- staff kitchen areas in shops, offices and other working environments;
- farm houses and by clients in hotels, motels and other residential type environments;
- bed and breakfast type environments;
- catering and similar non-retail applications.

---

## Instructions about the WEEE

---



### Correct Disposal of This Product (Waste Electrical & Electronic Equipment) (Applicable in countries with separate collection systems)

This marking on the product, accessories or literature indicates that the product and its electronic accessories (e.g. charger, headset, USB cable) should not be disposed of with other household waste at the end of their working life. To prevent possible harm to the environment or human health from uncontrolled waste disposal, please separate these items from other types of waste and recycle them responsibly to promote the sustainable reuse of material resources.

Household users should contact either the retailer where they purchased this product, or their local government office, for details of where and how they can take these items for environmentally safe recycling.

Business users should contact their supplier and check the terms and conditions of the purchase contract. This product and its electronic accessories should not be mixed with other commercial wastes for disposal.

For information on Samsung's environmental commitments and product specific regulatory obligations e.g. REACH visit: [samsung.com/uk/aboutsamsung/samsungelectronics/corporatecitizenship/data\\_corner.html](https://samsung.com/uk/aboutsamsung/samsungelectronics/corporatecitizenship/data_corner.html)

(For products sold in European countries only)

# Installation

Follow these instructions carefully to ensure a proper installation of this refrigerator and to prevent accidents before using it.

## **⚠ WARNING**

- Use the refrigerator only for its intended purpose as described in this manual.
- Any servicing must be performed by a qualified technician.
- Dispose of the product packaging material in compliance with the local regulations.
- To prevent electric shock, unplug the power cord before servicing or replacements.

## Refrigerator at a glance

The actual image and provided component parts of the refrigerator may differ, depending on the model and the country.

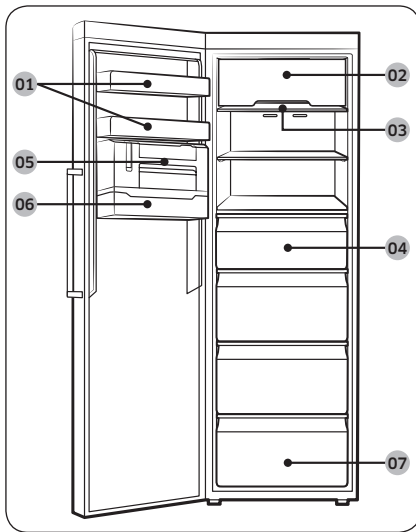

- 01** Door guard
  - 02** Top shelf cover \*
  - 03** Freezer shelf
  - 04** Freezer drawer
  - 05** Slim Ice Maker \*
  - 06** Ice cube guard \*
  - 07** Bottom drawer
- \* applicable models only

## **📄 NOTE**

- For best energy efficiency, make sure all of shelves, drawers, and baskets are placed in their original position.



---

## Step-by-step installation

---

### STEP 1 Select a site

---

#### Site requirements:

- Solid, level surface without carpeting or flooring that may obstruct ventilation
- Away from direct sunlight
- Adequate room for opening and closing the door
- Away from a heat source
- Room for maintenance and servicing
- Temperature range: between 10 °C and 43 °C

#### Effective temperature range

The refrigerator is designed to operate normally in the temperature range specified by its class rating.

| Class              | Symbol | Ambient Temperature range (°C) |            |
|--------------------|--------|--------------------------------|------------|
|                    |        | IEC 62552 (ISO 15502)          | ISO 8561   |
| Extended Temperate | SN     | +10 to +32                     | +10 to +32 |
| Temperate          | N      | +16 to +32                     | +16 to +32 |
| Subtropical        | ST     | +16 to +38                     | +18 to +38 |
| Tropical           | T      | +16 to +43                     | +18 to +43 |

#### NOTE

The cooling performance and power consumption of the refrigerator may be affected by the ambient temperature, the door-opening frequency, and the location of the refrigerator. We recommend adjusting the temperature settings as appropriate.

# Installation

## Clearance

See the pictures and table below for space requirements for installation.

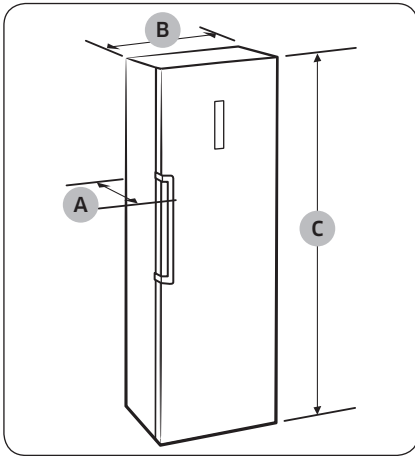

|                    |      |
|--------------------|------|
| Depth "A"          | 694  |
| Width "B"          | 595  |
| Overall Height "C" | 1853 |

(unit : mm)

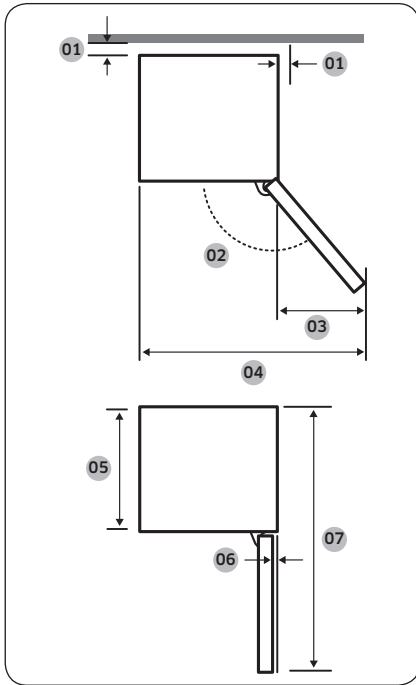

|    |                |
|----|----------------|
| 01 | at least 50 mm |
| 02 | 130°           |
| 03 | 377            |
| 04 | 967            |
| 05 | 575            |
| 06 | 5.5            |
| 07 | 1194           |

(unit : mm)

**NOTE**

The measurements in the above table may differ, depending on the measuring method.

**STEP 2 Spacing (applicable models only)**

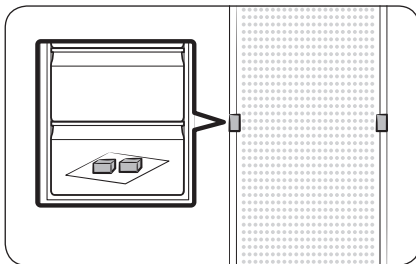

1. Open the door and locate the provided spacers (x2).
2. Unpack both spacers and attach them to the rear of the refrigerator as shown. They help ventilate air to the rear wall and save power consumption.

# Installation

## STEP 3 WiFi connection

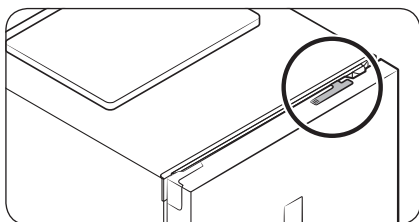

You can control the refrigerator remotely using the Smart Home Dongle that is sold separately. To purchase the Smart Home Dongle, visit [www.samsung.com](http://www.samsung.com) and follow the product information about the dongle.

### ⚠ CAUTION

- The Samsung Smart Home Dongle comes in two types: one that is dedicated to Samsung smart TVs, and the other one that is dedicated to Samsung home appliances.
- You must purchase the Samsung Smart Home Dongle dedicated to home appliances. Any other dongles may cause system failure.

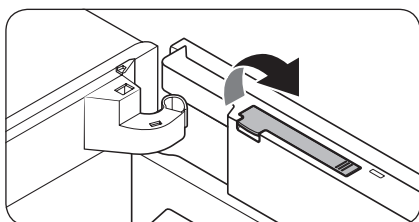

1. Open the freezer door, and pull up to open the dongle cover at the top of the door.

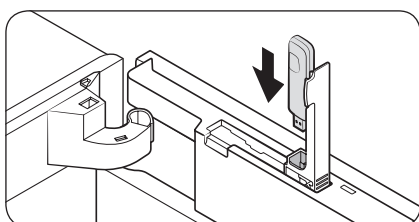

2. Insert the Smart Home Dongle into the dongle port in the correct direction.

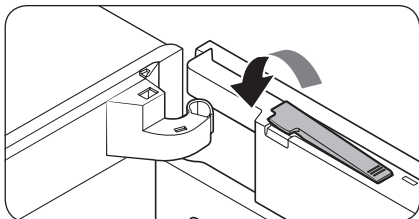

3. Push down to close the dangle cover.

#### STEP 4 Flooring

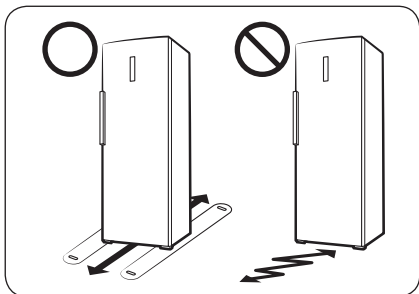

- The surface to install the refrigerator must support a fully loaded refrigerator.
- To protect the floor, put a large piece of cardboard on each foot of the refrigerator.
- Once the refrigerator is in its final position, do not move it unless necessary to protect the floor. If you have to, use a thick paper or cloth such as old carpet along the movement path.



# Installation

## STEP 5 Adjust the levelling legs

### ⚠ CAUTION

- The refrigerator must be levelled on a flat, solid floor. Failing to do so can cause damage to the refrigerator or physical injury.
- Levelling must be performed with an empty refrigerator. Make sure no food items remain inside the refrigerator.
- For safety reasons, adjust the front side a little higher than the rear side.

The refrigerator can be levelled using the front legs that have a special screw (leveller) for levelling purposes. Use a flat-head screwdriver for levelling.

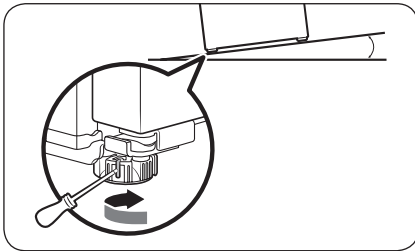

### To adjust the height of the left side:

Insert a flat-head screwdriver into the leveller of the front left leg. Turn the leveller clockwise to raise, or turn it counter clockwise to lower.

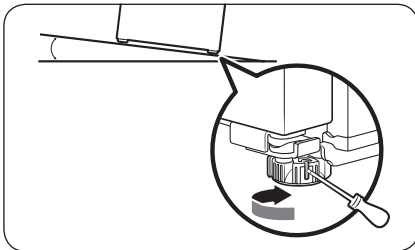

### To adjust the height of the right side:

Insert a flat-head screwdriver into the leveller of the front right leg. Turn the leveller clockwise to raise, or turn it counter clockwise to lower.



---

## STEP 6 Initial settings

---

By completing the following steps, the refrigerator should be fully functioning.

1. Remove the PE foam sheet on each shelf corner, which is attached to protect the refrigerator during transportation.
2. Plug the power cord into the wall socket to turn the refrigerator on .
3. Open the door, and check if the interior light lights up.
4. Set the temperature to the lowest, and wait until the refrigerator reaches the set temperature. Now the refrigerator is ready for use.

### NOTE

When the refrigerator powers on, the alarm will sound. To turn off the alarm, press Freezer.

## STEP 7 Final check

---

When installation is complete, confirm that:

- The refrigerator is plugged into an electrical outlet and grounded properly.
- The refrigerator is installed on a flat, level surface with a reasonable clearance from the wall or the cabinet.
- The refrigerator is level and is sitting firmly on the floor.
- The door opens and closes freely, and the interior light turns on automatically when you open the door.



# Operations

## Feature panel

### TYPE A

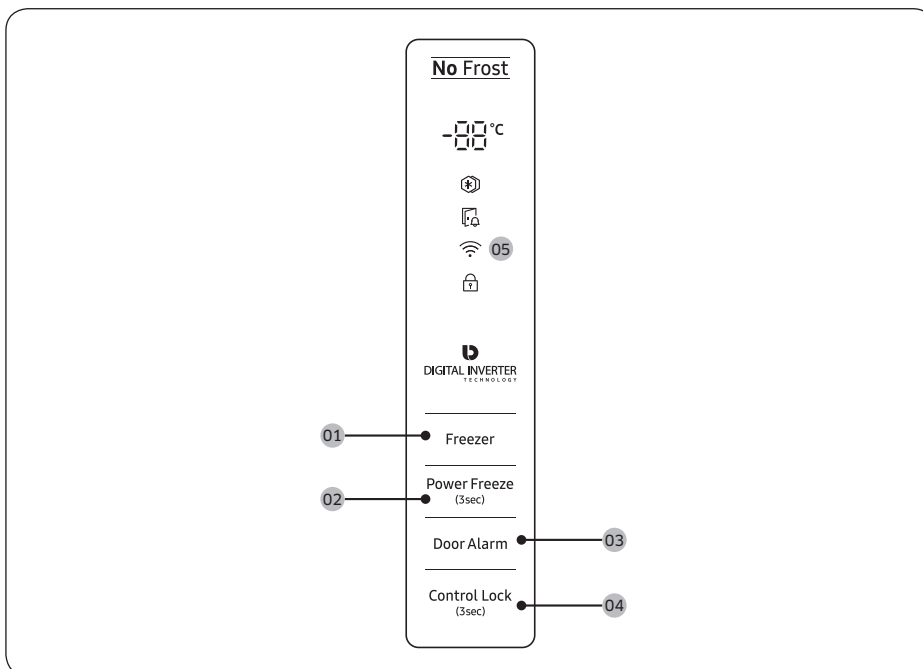

### TYPE B

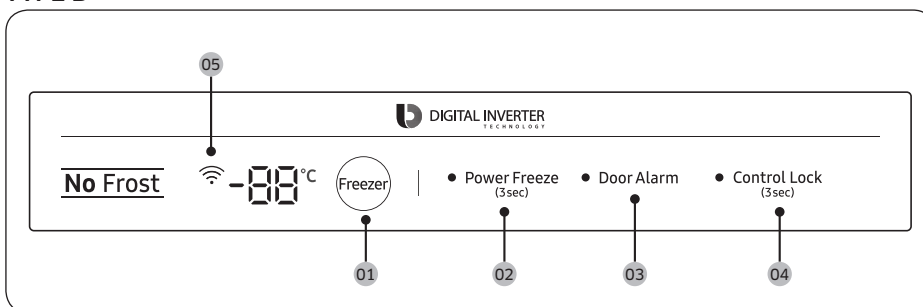





01 Freezer

02 Power Freeze

03 Door Alarm



04 Control Lock

05 Network connection

01 Freezer

|         |   |
|---------|---|
| Freezer | The <b>Freezer</b> button can be used to set the freezer temperature. Available temperatures are between -15 °C and -23 °C (default: -19 °C). |
|---------|---|

02 Power Freeze (3 sec)

|              |  |
|--------------|--|
| Power Freeze | <p>Power Freeze speeds up the freezing process at maximum fan speed. The freezer keeps running at full speed for 50 hours and then returns to the previous temperature.</p> <ul style="list-style-type: none"> <li>To activate Power Freeze, press and hold <b>Power Freeze</b> for 3 seconds. The corresponding indicator (  ) lights up, and the refrigerator will speed up the freezing process for you.</li> <li>To deactivate, press and hold <b>Power Freeze</b> for 3 seconds again. The freezer returns to the previous temperature setting.</li> <li>To freeze large amounts of food, activate Power Freeze for at least 20 hours before putting food in the freezer.</li> </ul> <p> <b>NOTE</b></p> <ul style="list-style-type: none"> <li>Using Power Freeze increases power consumption. Make sure you turn it off and return to the previous temperature if you do not intend to use it.</li> <li>To quickly freeze large quantities of food, remove the drawers and use the provided shelf.</li> </ul> |
|--------------|--|

03 Door Alarm

|            |   |
|------------|---|
| Door Alarm | <p>You can set the alarm for a reminder. If the door is left open for more than 2 minutes, the alarm will sound with the Alarm indicator blinking.</p> <p>You can toggle to enable and disable the alarm by pressing <b>Door Alarm</b>.</p> |
|------------|---|

04 Control Lock (3 sec)

|              |  |
|--------------|--|
| Control Lock | <p>To prevent accidental manipulation, press and hold <b>Control Lock</b> for 3 seconds to activate the Control Lock. All controls will be disabled with the indicator (  ) on.</p> <p>To deactivate, press and hold again for 3 seconds. The controls will be enabled as normal.</p> |
|--------------|--|



# Operations

---

## 05 Network connection

You can use the optional Smart Home Dongle (sold separately) to control and monitor your refrigerator through the Samsung Smart Home app. For more information about Samsung Smart Home, see the Samsung Smart Home section.

### NOTE

- Recommended encryption systems include WPA/TKIP and WPA2/AES. Any newer or unstandardized Wi-Fi authentication protocols are not supported.
- Wireless networks may be affected by the surrounding wireless communication environment.
- If your Internet service provider has registered the MAC address of your PC or modem for identification, your Samsung Smart Refrigerator may fail to connect to the Internet. If this happens, contact your Internet service provider for technical assistance.
- The firewall settings of your network system may prevent your Samsung Smart Refrigerator from accessing the Internet. Contact your Internet service provider for technical assistance. If this symptom continues, contact a local Samsung service center or retailer.
- To configure the wireless access point (AP) settings, see the user manual of the AP.
- Samsung Smart Refrigerators featuring the Samsung Smart Home Dongle support both Wi-Fi 2.4 GHz with IEEE 802.11 b/g/n and Soft-AP protocols (IEEE 802.11 n is recommended).
- Unauthorized Wi-Fi wireless routers may fail to connect to applicable Samsung Smart Refrigerators.



---

## Samsung Smart Home

---

### Installation

Visit the Google Play Store, Galaxy Apps, or Apple App Store and search for “Samsung Smart Home”. Download and install the Samsung Smart Home app provided by Samsung Electronics to your smart device.

#### NOTE

- The Samsung Smart Home app is designed for Android 4.0 (ICS) or higher, or iOS 8.0 or higher, and is optimized for Samsung smartphones (Galaxy S and Galaxy Note series). On other smartphone models, some functions may operate differently.
- For improved performance, the Samsung Smart Home app is subject to change without notice, or discontinued support according to the manufacturer’s policy.

### Samsung account

You are required to register your Samsung account to use the app. If you don't have a Samsung account, follow the app's onscreen instructions to create a free Samsung account.

### Getting started

1. Insert the Smart Home Dongle into the corresponding port of your refrigerator.
2. Run the Samsung Smart Home app and log in with your Samsung account. iPhone users are required to provide the login information each time they access the app.
3. Tap **Add Device** > **Refrigerator**.
4. Follow the onscreen instructions to provide the necessary information about the router, and then tap **Next**.
5. Press and hold **Freezer** for more than 5 seconds until the "AP" message appears on the display. Your refrigerator will be registered with the app.
6. When the device registration is complete, the refrigerator icon will appear on the Samsung Smart Home app.
7. Tap the refrigerator icon to open the refrigerator page.
8. When a network connection is established, the Wi-Fi icon lights up on your refrigerator.

### Refrigerator app

#### Integrated control

You can monitor and control your refrigerator at home as well as while on the move.

- Tap the refrigerator icon on the Samsung Smart Home to open the refrigerator page.
- Check the operation status or notification of your refrigerator, and change options or settings if necessary.

#### NOTE

Some options or settings of the refrigerator may not be available for remote control.



# Operations

---

| Category   | Item                        | Description  |
|------------|-----------------------------|--|
| Monitoring | Freezer temperature         | Displays the current temperature setting of the freezer.                       |
|            | Diagnosis                   | Detects abnormal operations of the freezer.                                    |
|            | Energy monitoring           | Checks the accumulated power consumption of the freezer for the last 180 days. |
| Functions  | Power Freeze                | You can turn Power Freeze on or off, and check the current settings.           |
| Alarms     | Abnormally high temperature | This alarm is triggered when the freezer has abnormally high temperatures.     |
|            | Door opening                | This alarm is triggered if the freezer door is open for a specific time.       |

---

## Special features

---

The actual image and special functions of your refrigerator may differ depending on the model and the country.

### Slim Ice Maker (applicable models only)

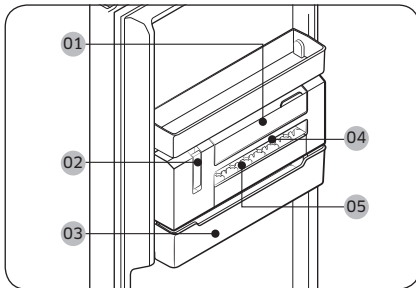

- 01 Water bin
- 02 Ice maker lever
- 03 Ice bucket
- 04 Ice template
- 05 Ice template cover

#### NOTE

If you do not intend to make ice, remove the Slim Ice Maker to secure more room for storage. In this case, you can use the **ice bucket (03)** as a multipurpose storage bin.

# Operations

To dispense ice manually

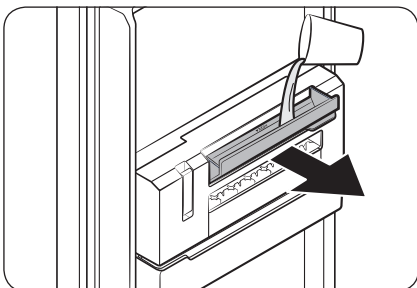

1. Pull up the handle of the **water bin (01)** to open, and then fill the bin with water up to the max line. Gently close the bin so that water does not drop or leak.

**⚠ CAUTION**

- Do not exceed the max line. Excessive water causes the ice to jam and not dispense well.
- Use only potable water. Other liquids, such as green tea or milk may not dispense well.
- Gently close the **water bin**. Otherwise, the water may drop or leak.

**📖 NOTE**

- If you encounter a water leak, open the **water bin** and check if the water bin's passage to the **ice template** is frozen. If this is the case, pour lukewarm water into the **water bin** up to the max line. Let the passage melt.
- It is recommended to clean the water bin's passage to the **ice template** on a regular basis because the passage is likely to freeze.

2. Check if the ice has frozen completely. Only when the ice has frozen completely, pull up the **ice maker lever (02)**. Then, the **ice template (04)** rotates and dispenses ice to the **ice bucket (03)**.

**⚠ CAUTION**

- Do not pull up the lever until the ice has frozen completely. Half-frozen ice may jam and damage the **ice bucket**.

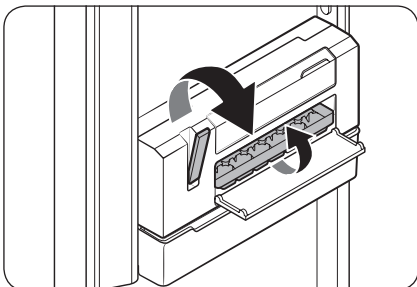

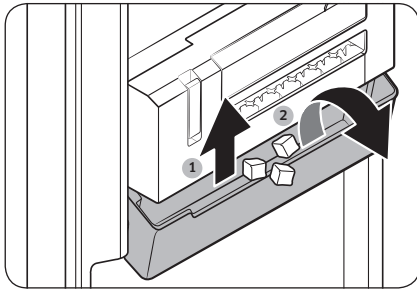

3. To dispense ice, slightly lift up the **ice bucket** and tilt to the front.

**⚠ CAUTION**

- Do not tilt without lifting the **ice bucket**. The **ice bucket** may break.
- Do not pour water directly into the **ice bucket** for ice making. The **ice bucket** may break.
- Do not leave the freezer door open. The ice in the **ice bucket** melts and jams.
- In case of a power failure, make sure to empty the **ice bucket** before making ice.
- Use only potable water.

**📄 NOTE**

- The ice cubes may not dispense at once, depending on the ice state. In this case, try pulling the lever several times.
- If the ice does not dispense because an excessive amount of water was filled, remove the **ice template** and empty. If this issue continues, uninstall the Slim Ice Maker unit and empty.

# Operations

## To open the top shelf cover (applicable models only)

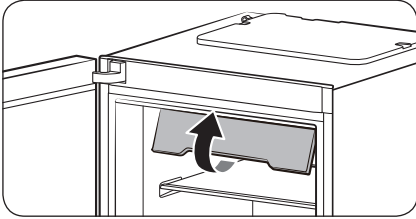

1. Fully pull up the front end of the top shelf cover.

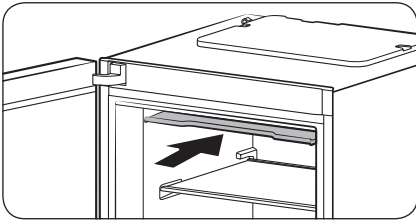

2. Then, push the cover inwards to the end.

### NOTE

- To remove or put an item from the freezer, you must fold up the top shelf cover first.
- The top shelf cover is removable. You can remove it if you do not intend to use it.



---

### To secure more storage space (applicable models only)

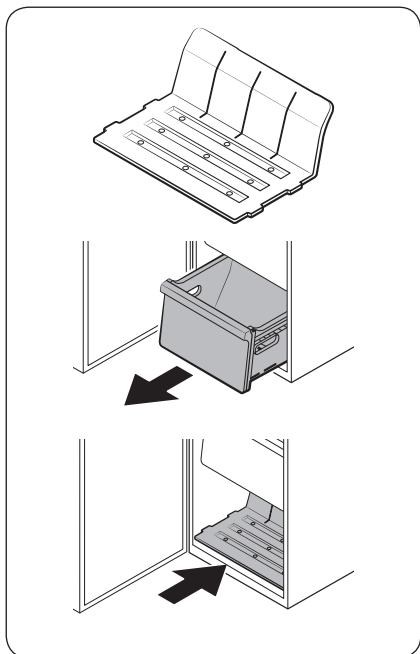

If you need more storage space, remove the top shelf cover and all 4 drawers and insert the provided shelf (see the figure) in the inner bottom of the main unit. Then, remove the Slim Ice Maker.

 **NOTE**

- Removal of the top shelf cover and the drawers does not affect thermal and mechanical characteristics of the freezer.
- A declared storage volume of the freezer is based on the conditions where the top shelf cover and all the drawers are removed and the provided shelf is inserted.

# Maintenance

## Door reversal (applicable models only)

Reversing the door must be performed by Samsung-approved servicing personnel at your own expense because this kind of servicing is not covered by the Warranty.

### ⚠ WARNING

- Reversing failure or property damage that may occur by unapproved agencies will not be covered by the Warranty.
- Make sure that the refrigerator is disconnected from the power source before doing the reversal.
- You must wait for at least an hour after door reversing is complete. This is to prevent electric shock that could occur.

### Tools required (not provided)

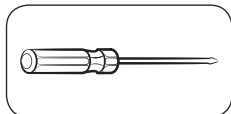

Phillips screwdriver

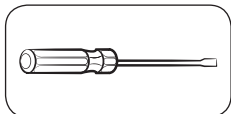

Flat-head screwdriver



10 mm spanner  
(for top hinge shaft)

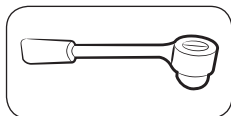

8 mm socket wrench  
(for bolts)



12 mm spanner  
(for bottom hinge shaft)

### Accessories

The appearance of the accessories listed below may differ with the model.

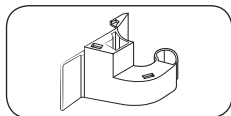

Hinge cover (L)

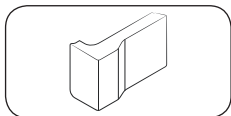

Space cover (L)

### ⚠ CAUTION

Throughout the entire reversing procedure, keep all the small parts (screws, caps, etc.) of the refrigerator away from children or infants for safety reasons.

## Step-by-step instructions

### STEP 1 Remove the handle

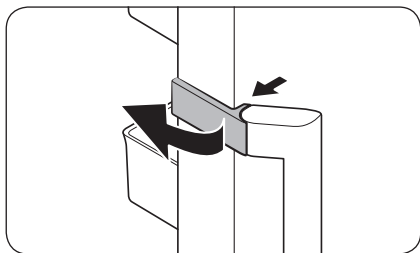

1. Unlock the **handle cap** and put it aside.

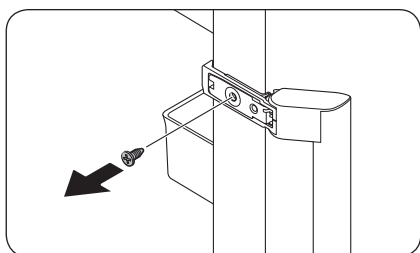

2. Remove each screw on the upper and lower side of the handle.

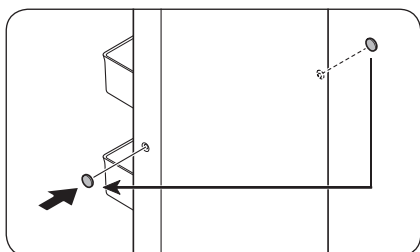

3. Use a flat-head screwdriver to remove the **handle screw caps** (x2). Then, insert the **handle screw caps** in the opposite side.

#### **⚠ CAUTION**

To prevent physical damage, use caution when removing the **handle screw caps**.

#### **📖 NOTE**

Keep the handle safe for later use.

# Maintenance

## STEP 2 Remove the freezer door

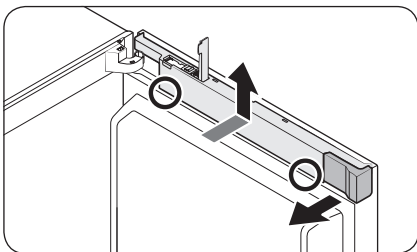

1. Open the **dongle cover**, and remove the **space cover**.
2. While holding down the lower areas (marked in the figure) of the **wire cover** with both hands, lift up the **wire cover**.

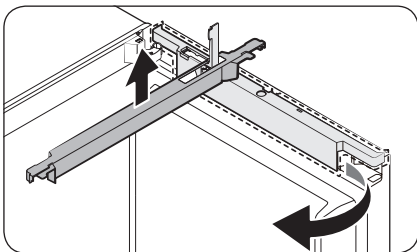

3. Turn the **wire cover** to the front by 90 degrees, and then push up to remove.

### **NOTE**

Keep both the **space cover** and the **wire cover** in a safe place. They are necessary when you return the door to the initial position (before reversing the door).

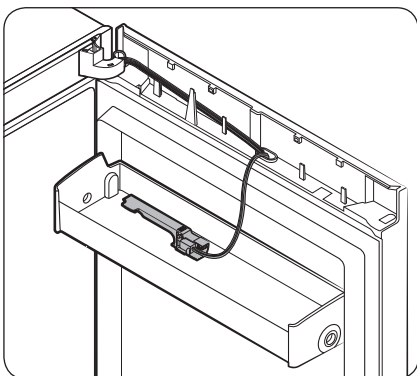

### **NOTE**

Put the **dongle cover** on the door guard for later use.

## Display Type A

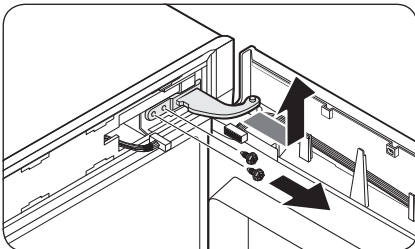
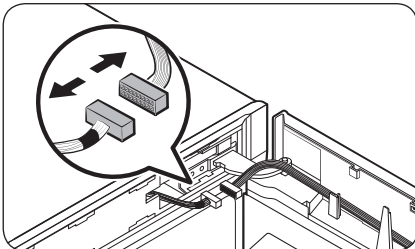
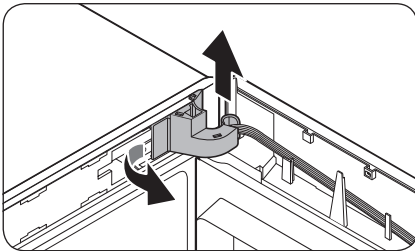
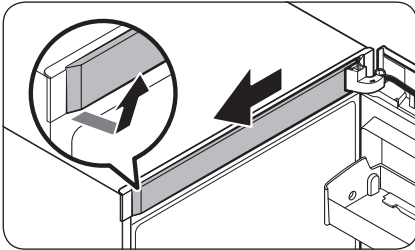

1. Remove the **top frame cover** from the right side first. Then, pull out to the front.

2. Pull out the left side of the **hinge cover** to remove, and then slightly lift up the bottom to pull out.

### ⚠ CAUTION

When removing the **hinge cover**, use caution not to damage the connectors and wires on or around the freezer door.

### 📖 NOTE

Keep the **hinge cover** in a safe place. It is necessary when you return the door to the initial position (before reversing the door).

3. Disconnect the connectors on or around the freezer door. Loosen the screws from the **top hinge** to remove.

### ⚠ CAUTION

To prevent the freezer door from falling, make sure to hold the freezer door tight while removing the **top hinge**.

# Maintenance

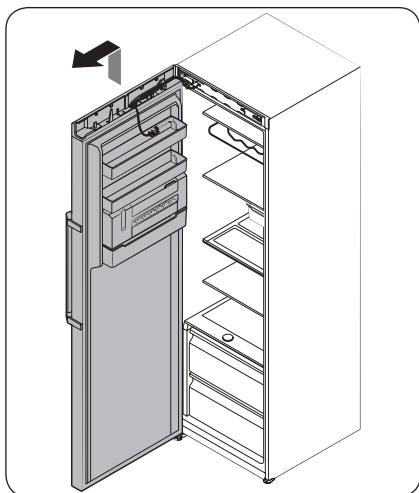

4. When the **top hinge** is removed, lift up to remove the freezer door. Keep the door in a safe place.

**⚠ CAUTION**

The door is heavy. To prevent damage or injury, use caution while removing the door.

## Display Type B

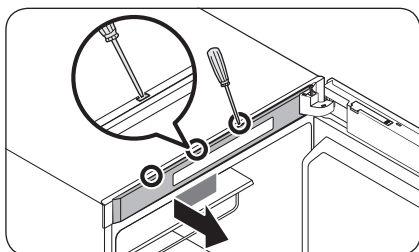

1. Use a flat-head screwdriver to insert in the holes one after another on the top of the door to remove the **top frame cover**.

**📖 NOTE**

Start with the hole farthest from the hinge.

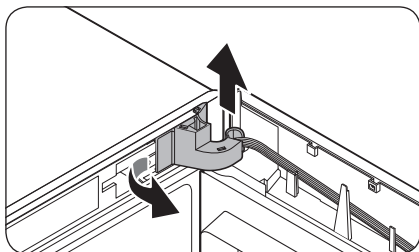

2. Pull out the left side of the **hinge cover** to remove, and then slightly lift up the bottom to pull out.

**⚠ CAUTION**

When removing the **hinge cover**, use caution not to damage the connectors and wires on or around the freezer door.

**📖 NOTE**

Keep the **hinge cover** in a safe place. It is necessary when you return the door to the initial position (before reversing the door).

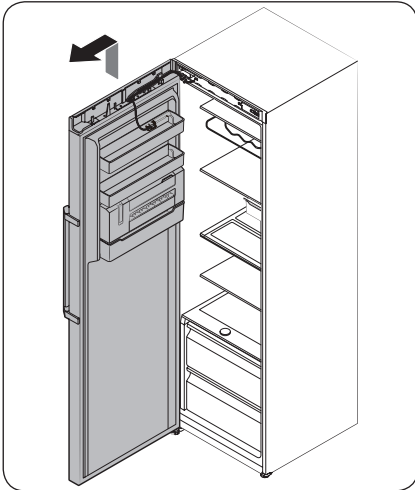
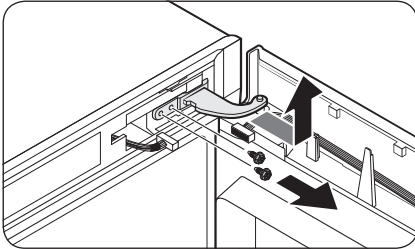
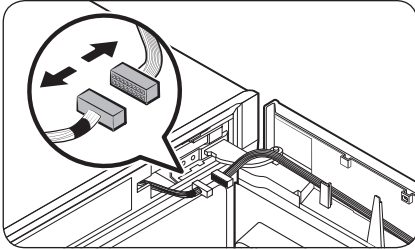

3. Disconnect the connectors on or around the freezer door. Loosen the screws from the **top hinge** to remove.

**⚠ CAUTION**

To prevent the freezer door from falling, make sure to hold the freezer door tight while removing the top hinge.

4. When the **top hinge** is removed, lift up to remove the freezer door. Keep the door in a safe place.

**⚠ CAUTION**

The door is heavy. To prevent damage or injury, use caution while removing the door.

# Maintenance

---

## STEP 3 Reverse the auto closer

---

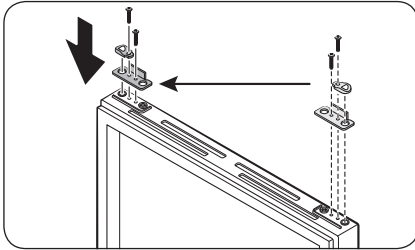

1. From the freezer door, remove the **auto closer lever** by loosening the screws on the lever and the screws in the opposite side.
2. Insert the **auto closer lever** in the opposite side, and tighten the screws.



## STEP 4 Reverse the bottom hinge

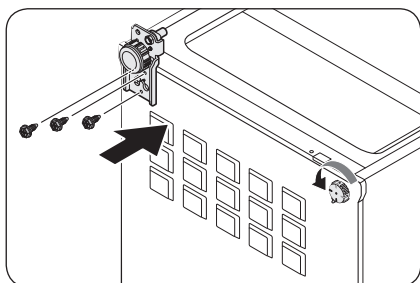
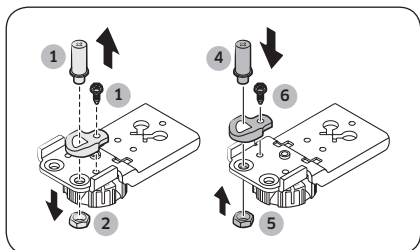
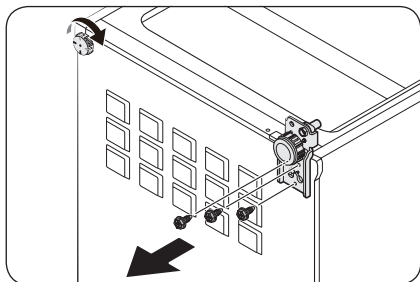

1. Lay down the refrigerator with care. Then, remove the screws from the **bottom hinge** on the right side and the **levelling leg** on the left side, respectively.
2. Use an 8 mm socket wrench to remove the **rear bolt** next to the **shaft**.
3. Remove the **shaft bolt** beneath the **bottom hinge**.
4. Use a Phillips screwdriver to remove the **shaft**.
5. Insert the **shaft** in the opposite side.
6. Reinsert and tighten the **rear bolt**.
7. Reinsert and tighten the **shaft bolt**.
8. Insert the **bottom hinge** in the opposite side and tighten with screws. Mount the **levelling leg** in the opposite side and tighten with screws.
9. Stand the refrigerator with care.

# Maintenance

## STEP 5 Reattach the freezer door

Display Type A

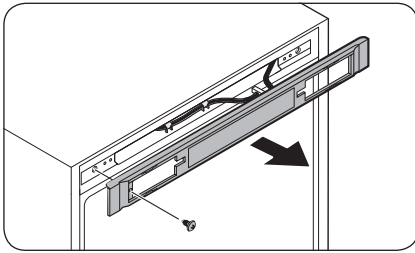

1. Remove the screw and pull out the control cover.

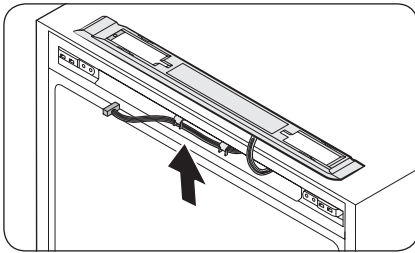

2. Move the connectors and wires to the opposite side. Insert the control cover, and then tighten the screws on the opposite side.

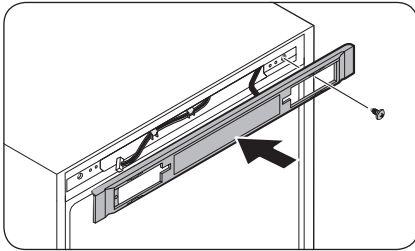

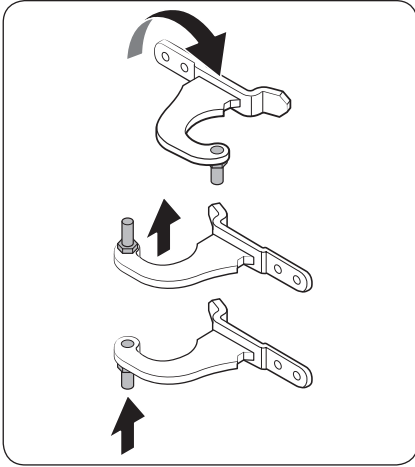

3. Remove the **shaft** from the **top hinge**. Then, reassemble the **shaft** as shown.

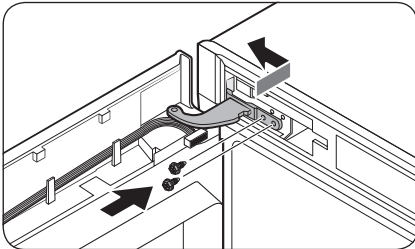

4. Insert the bottom of the door first into the main unit.
5. Insert the **top hinge** and tighten it with screws.

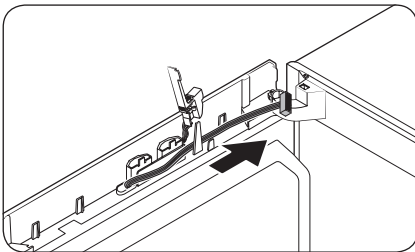

- Move the wires to the opposite side and fix them on the inner hook of the opposite side.

# Maintenance

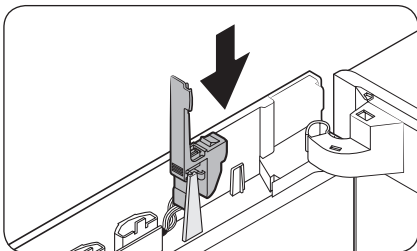

6. Reinsert the **dongle cover** in the original position.

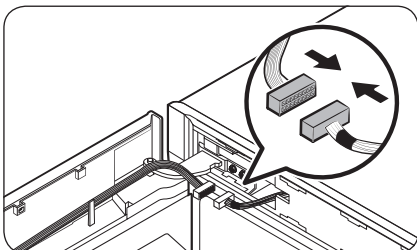

7. Connect the connectors from the freezer door and the main unit. Then, fix the wires on the inner hook of the optional hinge cover (L).

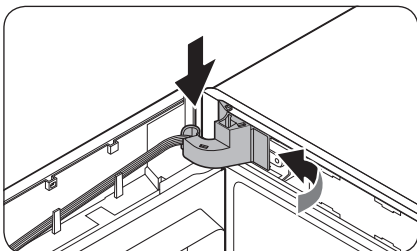
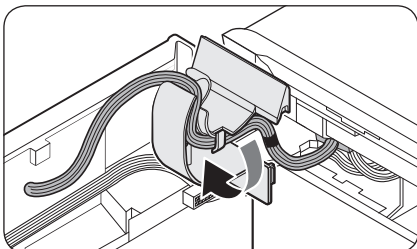

8. Insert the **hinge cover** in the **top hinge** with the right side first. Then, press the bottom of the cover to fit.

**⚠ CAUTION**

Make sure all of the wires and connectors are not stuck in the middle.

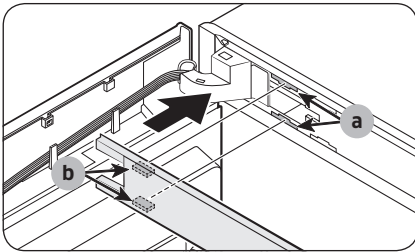

9. Insert the **top frame cover** with the **part (b)** fitting in the **part (a)** diagonally.

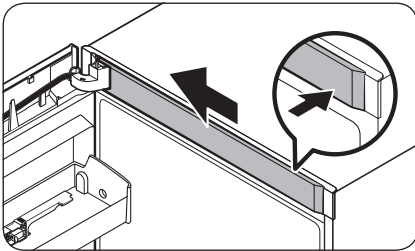

10. Insert the **wire cover** through the opened **dongle cover**. Turn the cover by 90 degrees to the front, and then push down to fit in.

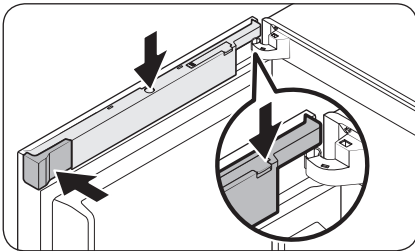

11. Insert the **space cover (L)** into the original position, and then close the **dongle cover**.

**NOTE**

The appearance of the covers differ with the model.

**Display Type B**

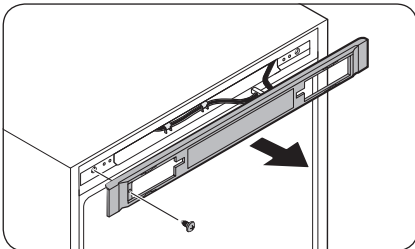

1. Remove the screw and pull out the **control cover**.

# Maintenance

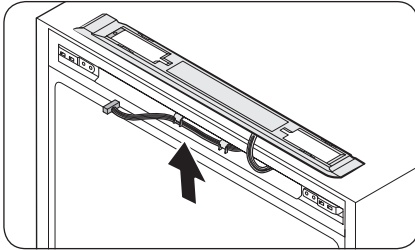

2. Move the connectors and wires to the opposite side. Insert the **control cover**, and then tighten the screws on the opposite side.

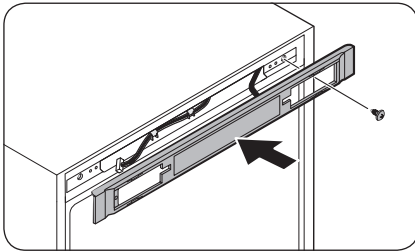

3. Remove the **shaft** from the **top hinge**. Then, reassemble the **shaft** as shown.

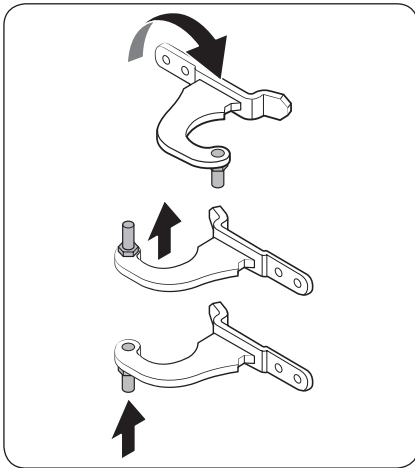

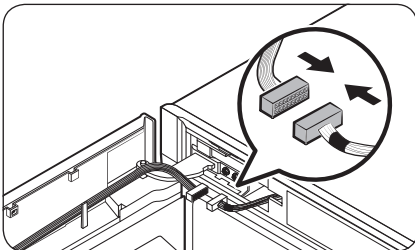
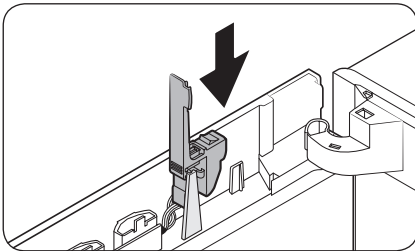
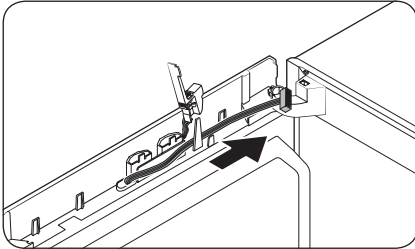
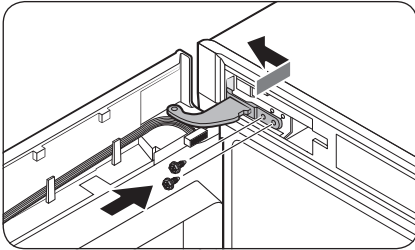

4. Insert the bottom of the door first into the main unit.
5. Insert the **top hinge** and tighten it with screws.

- Move the wires to the opposite side and fix them on the inner hook of the opposite side.

6. Reinsert the **dongle cover** in the original position.

7. Connect the connectors from the freezer door and the main unit. Then, fix the wires on the inner hook of the optional hinge cover (L).

# Maintenance

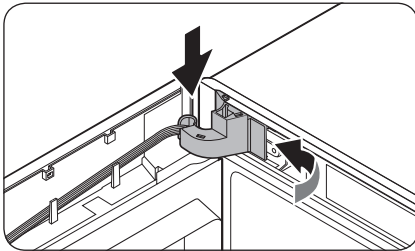
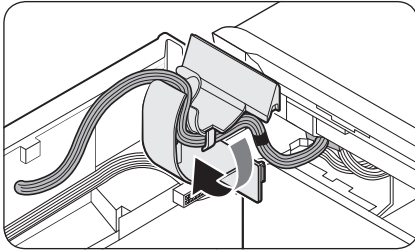

8. Insert the **hinge cover** in the **top hinge** with the right side first. Then, press the bottom of the cover to fit.

**⚠ CAUTION**

Make sure all of the wires and connectors are not stuck in the middle.

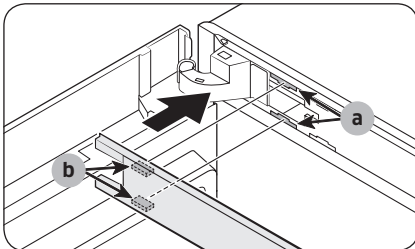

9. Insert the **top frame cover** with the **part (b)** fitting in the **part (a)** diagonally. Then, slide the end of the cover to the left to lock.

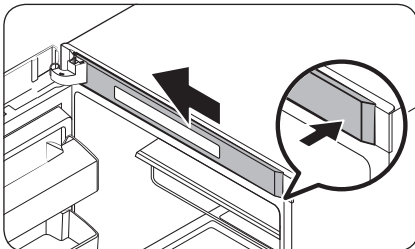



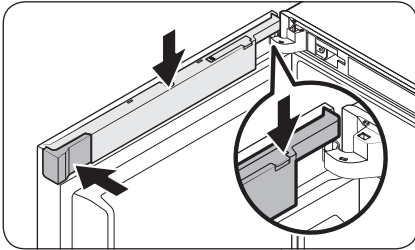
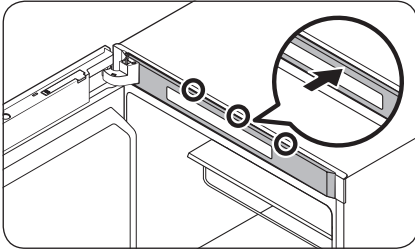
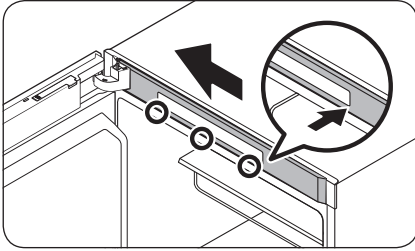

- For models that have the display panel on the top of the freezer, push in the left end of the **top frame cover** then the right side by locking the lower and upper areas in this sequence.

10. Insert the **wire cover** through the opened **dongle cover**. Turn the cover by 90 degrees to the front, and then push down to fit in.

11. Insert the **space cover (L)** into the original position, and then close the **dongle cover**.

**NOTE**

The appearance of the covers differ with the model.

# Maintenance

## STEP 6 Reattach the handle

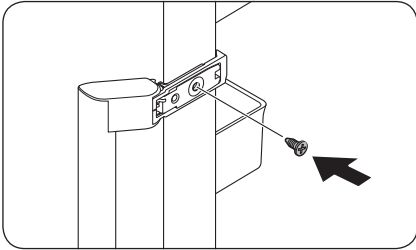

1. Insert the handle in the opposite side, and then tighten the screw.

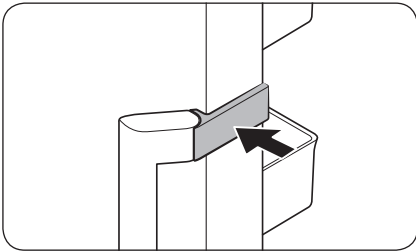

2. Close the **handle cover** as shown.

### NOTE

You might want to return the doors to the initial position (before reversing the door). In that case, refer to the instructions above but switch the doors, hinges, and covers back to the initial position.

---

## Handle and care

---

### Shelves

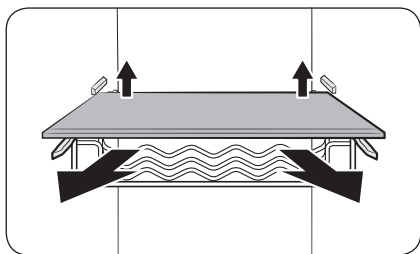

Slightly lift up the rear side of the shelf to pull out.

### Door guards

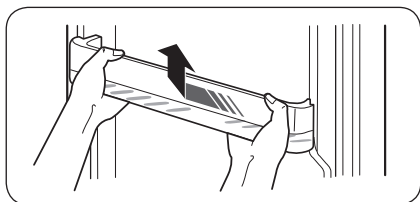

Slightly lift up and pull out the door guard.

**⚠ CAUTION**

To prevent accidents, empty the door guards before removing.

### Top shelf cover (applicable models only)

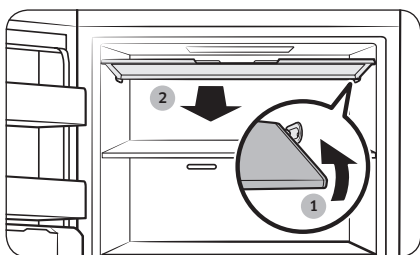

1. Push the right side of the cover inwards to unhook the cover.
2. Then, pull up the cover to the front to remove.

# Maintenance

## Slim Ice Maker (applicable models only)

### NOTE

- When cleaning the component parts of the Slim Ice Maker such as the **water bin**, **ice bucket**, and **ice template**, make sure they are completely dry after cleaning.
- When cleaning the Slim Ice Maker unit, make sure to completely dry the inner and outer parts of the unit after cleaning. Incomplete dryness may cause the ice maker lever to fail. In this case, dry the Slim Ice Maker completely for 2-3 days. Then, try again.

To remove the component parts

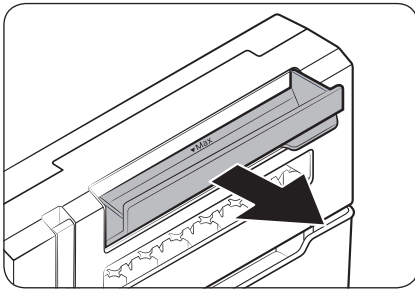

### Water bin

Fully open the **water bin**, and then pull out.

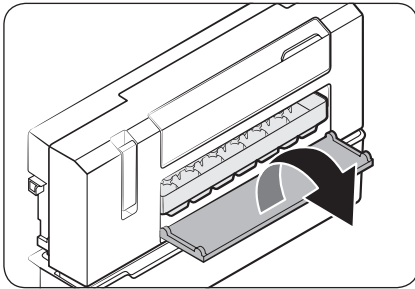

### Ice template

1. Open the **ice template cover** to reveal the **ice template**.

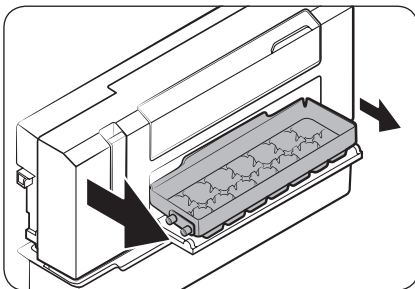

2. Slightly pull out the left side of the **ice template**, and then pull out the other side to remove.

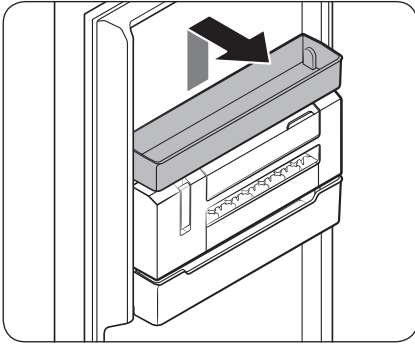

### Slim Ice Maker

1. Remove the multipurpose bin first, which is immediately above the Slim Ice Maker.

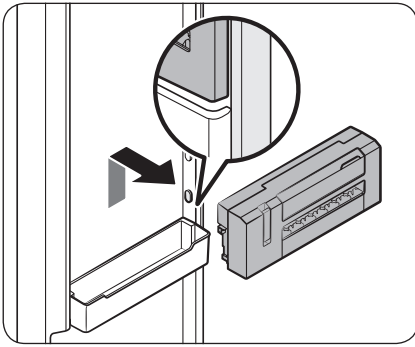

2. While holding the marked area on either side of the Slim Ice Maker unit with both hands, lift up the unit and pull out to the front.

To reinsert the component parts

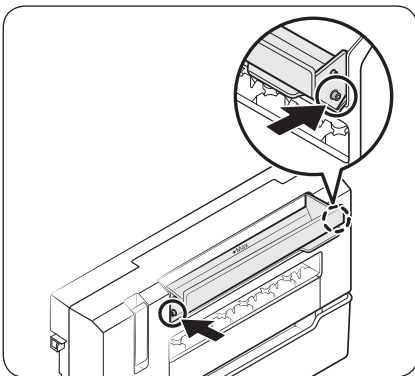

### Water bin

Fit either side of the **water bin** into the corresponding hook on the water bin housing. Make sure to fit until you hear a clicking sound.

# Maintenance

---

## Cleaning

---

### Interior and exterior

**⚠ WARNING**

- Do not use benzene, thinner, or home/car detergent such as Clorox™ for cleaning purposes. They may damage the surface of the refrigerator and cause a fire.
- Do not spray water onto the refrigerator. This may cause electric shock.

Regularly use a dry cloth to remove all foreign substances such as dust or water from the power plug terminals and contact points.

1. Unplug the power cord.
2. Use a moistened, soft, lint-free cloth or paper towel to clean the refrigerator's interior and exterior.
3. When done, use a dry cloth or paper towel to dry well.
4. Plug in the power cord.

## Replacement

---

### LED Lamps

To replace the lamps of the refrigerator, contact a local Samsung service centre.

**⚠ WARNING**

- The lamps are not user-serviceable. Do not attempt to replace a lamp yourself. This can cause electric shock.

# Troubleshooting

Before calling for service, review the checkpoints below. Any service calls regarding normal situations (No Defect Cases) will be charged to users.

## General

### Temperature

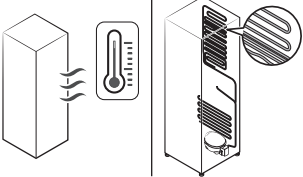
| Symptom   | Possible causes  | Solution   |
|---|--|--|
| Freezer does not operate.<br>Freezer temperature is warm. | <ul style="list-style-type: none"> <li>Power cord is not plugged in properly.</li> </ul>                                   | <ul style="list-style-type: none"> <li>Properly plug in the power cord.</li> </ul>   |
|   | <ul style="list-style-type: none"> <li>Temperature control is not set correctly.</li> </ul>                                | <ul style="list-style-type: none"> <li>Set the temperature lower.</li> </ul>   |
|   | <ul style="list-style-type: none"> <li>Refrigerator is located near a heat source or direct sunlight.</li> </ul>           | <ul style="list-style-type: none"> <li>Keep the refrigerator away from direct sunlight or a heat source.</li> </ul>  |
|   | <ul style="list-style-type: none"> <li>Not enough clearance between refrigerator and sides/rear.</li> </ul>                | <ul style="list-style-type: none"> <li>Make sure there are at least 5 cm from the rear and sides.</li> </ul>   |
|   | <ul style="list-style-type: none"> <li>The refrigerator is overloaded. Food is blocking the refrigerator vents.</li> </ul> | <ul style="list-style-type: none"> <li>Do not overload the refrigerator. Do not allow food to block ventilation.</li> </ul>  |
| Freezer is over-cooling.                                  | <ul style="list-style-type: none"> <li>Temperature control is not set correctly.</li> </ul>                                | <ul style="list-style-type: none"> <li>Set the temperature higher.</li> </ul>  |
| Interior wall is hot.                                     | <ul style="list-style-type: none"> <li>Refrigerator has heat-proof piping in the interior wall.</li> </ul>                 | <ul style="list-style-type: none"> <li>To prevent condensation from forming, the refrigerator has heat-proof piping in the front corners. If the ambient temperature rises, this equipment may not work effectively. This is not a system failure.</li> </ul>  |

# Troubleshooting

## Odors

| Symptom                 | Possible causes           | Solution  |
|-------------------------|---------------------------|---|
| Refrigerator has odors. | • Spoiled food.           | • Clean the refrigerator and remove any spoiled food. |
|                         | • Food with strong odors. | • Make sure strong smelling food is wrapped airtight. |

## Frost

| Symptom                          | Possible causes   | Solution   |
|----------------------------------|---|--|
| Frost around the vents.          | • Food is blocking the vents.                             | • Make sure no food blocks the refrigerator vents.               |
| Frost on interior walls.         | • Door is not closed properly.                            | • Make sure food does not block the door. Clean the door gasket. |
| Fruits or vegetables are frozen. | • Fruits or vegetables are stored in the Fresh/Chef Zone. | • The Fresh/Chef Zone is only for meat/fish.                     |

## Condensation

| Symptom                                   | Possible causes   | Solution  |
|---|---|---|
| Condensation forms on the interior walls. | • If door is left open, moisture enters the refrigerator. | • Remove the moisture and do not open the door for a long time. |
|   | • Food with high moisture content.                        | • Make sure food is wrapped airtight.                           |



## Do you hear abnormal sounds from the refrigerator?

Before calling for service, review the checkpoints below. Any service calls related to normal sounds will be charged to the user.

### These sounds are normal.

- When starting or ending an operation, the refrigerator may make sounds similar to a car engine igniting. As the operation stabilizes, the sounds will decrease.

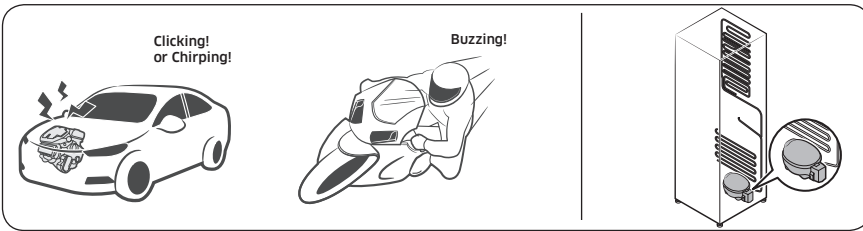

- While the fan is operating, these sounds may occur. When the refrigerator reaches the set temperature, no fan sound will occur.



- During a defrost cycle, water may drip on the defrost heater, causing sizzling sounds.

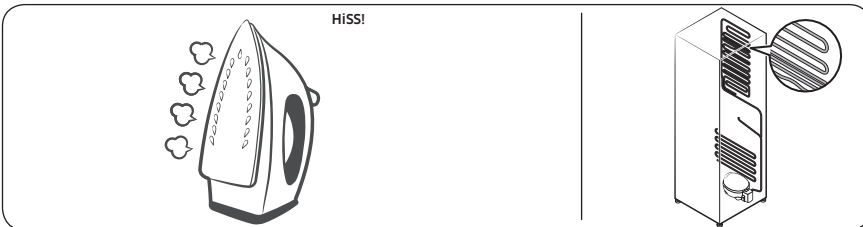

# Troubleshooting

- As the refrigerator cools or freezes, refrigerant gas moves through sealed pipes, causing bubbling sounds.

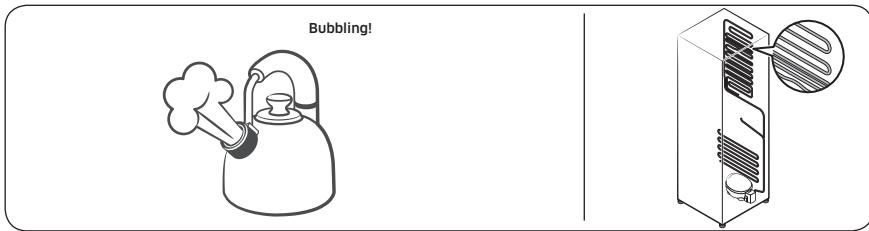

- As the refrigerator temperature increases or decreases, plastic parts contract and expand, creating knocking noises. These noises occur during the defrosting cycle or when electronic parts are working.

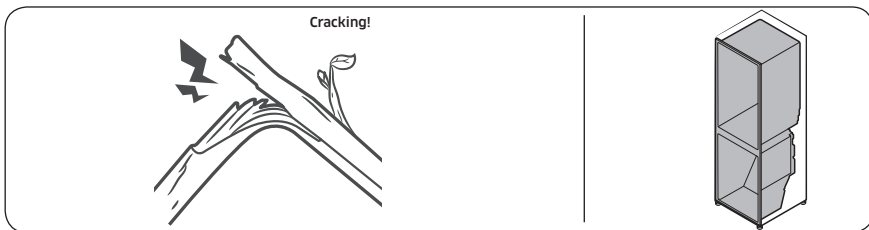

- For ice maker models: When the water valve opens to fill the ice maker, buzzing sounds may occur.
- Due to pressure equalizing when opening and closing the refrigerator door, whooshing sounds may occur.

## Samsung Smart Home

| Symptom   | Action  |
|---|---|
| Could not find "Samsung Smart Home" on the app market.                                    | <ul style="list-style-type: none"><li>The Samsung Smart Home app is available on smartphones that run Android 4.0 (ICS) or higher, or iOS 8.0 or higher.</li></ul>  |
| The Samsung Smart Home app fails to operate.  | <ul style="list-style-type: none"><li>The Samsung Smart Home app is available on applicable models only.</li><li>The old Samsung Smart Refrigerator app cannot connect with Samsung Smart Home models.</li></ul>  |
| The Samsung Smart Home app is installed but is not connected to my refrigerator.          | <ul style="list-style-type: none"><li>You must log into your Samsung account to use the app.</li><li>Make sure that your router is operating normally.</li><li>If you have not connected your refrigerator to the Samsung Smart Home App after the app was installed, you must make connection using the device registration function of the app.</li></ul> |
| Could not log into the app.   | <ul style="list-style-type: none"><li>You must log into your Samsung account to use the app.</li><li>If you don't have a Samsung account, follow the app's onscreen instructions to create one.</li></ul>   |
| An error message appears when I try to register my refrigerator.                          | <ul style="list-style-type: none"><li>Easy Connection may fail due to the distance from your access point (AP) or electrical interference from the surrounding environment. Wait a moment and try again.</li></ul>  |
| The Samsung Smart Home app is successfully connected to my refrigerator but does not run. | <ul style="list-style-type: none"><li>Exit and restart the Samsung Smart Home app, or disconnect and reconnect the router.</li><li>Unplug the power cord of the refrigerator, and then plug it in again after 1 minute.</li></ul>   |

# SAMSUNG

## Contact SAMSUNG WORLD WIDE

If you have any questions or comments relating to Samsung products, please contact the SAMSUNG customer care center.

| Country      | Contact Center          | Web Site   |
|--------------|-------------------------|--|
| SINGAPORE    | 1800-SAMSUNG(726-7864)  | <a href="http://www.samsung.com/sg/support">www.samsung.com/sg/support</a> |
| UK           | 0330 SAMSUNG (7267864)  | <a href="http://www.samsung.com/uk/support">www.samsung.com/uk/support</a> |
| SOUTH AFRICA | 0860 SAMSUNG (726 7864) | <a href="http://www.samsung.com/support">www.samsung.com/support</a>       |



DA68-03561A-01